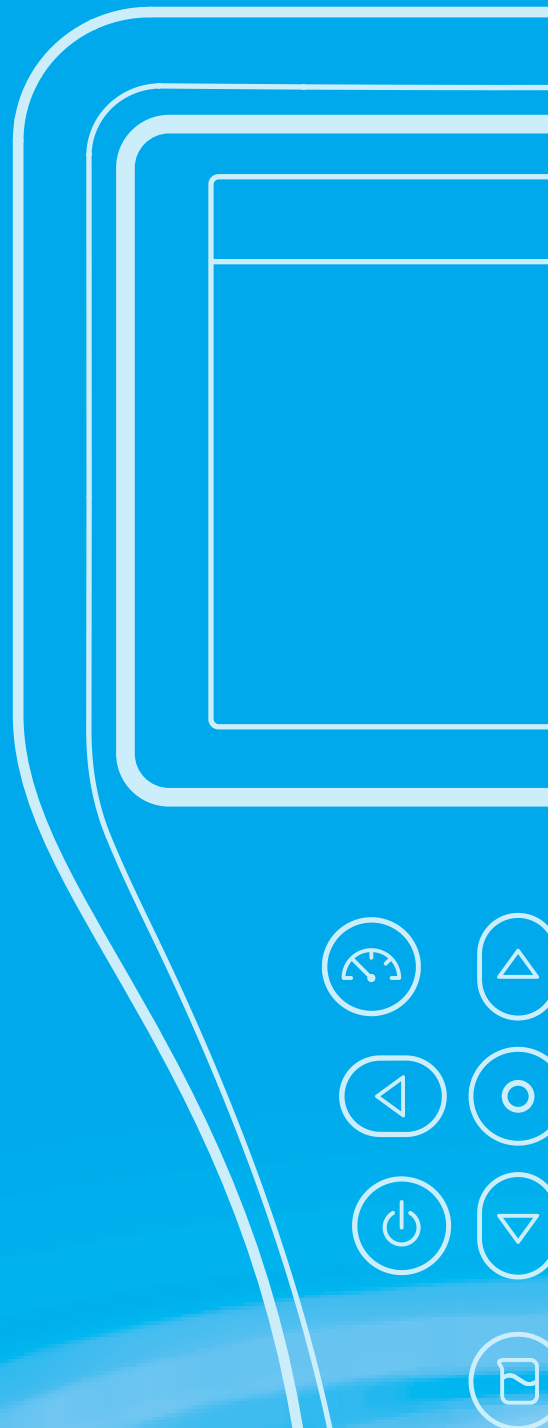

INSTRUCTION MANUAL

MULTI-PARAMETER WATER QUALITY CHECKER

U-50_{series}

CODE: GZ0000230552H

HORIBA
Process & Environmental



Preface

This manual describes the operation of the Multi-parameter Water Quality Checker, U-50 Series.

Be sure to read this manual before using the product to ensure proper and safe operation of the product. Also safely store the manual so it is readily available whenever necessary.

Product specifications and appearance, as well as the contents of this manual are subject to change without notice.

Warranty and responsibility

HORIBA Advanced Techno Co., Ltd. warrants that the Product shall be free from defects in material and workmanship and agrees to repair or replace free of charge, at option of HORIBA Advanced Techno Co., Ltd., any malfunctioned or damaged Product attributable to responsibility of HORIBA Advanced Techno Co., Ltd. for a period of one (1) year from the delivery unless otherwise agreed with a written agreement. In any one of the following cases, none of the warranties set forth herein shall be extended;

- Any malfunction or damage attributable to improper operation
- Any malfunction attributable to repair or modification by any person not authorized by HORIBA Advanced Techno Co., Ltd.
- Any malfunction or damage attributable to the use in an environment not specified in this manual
- Any malfunction or damage attributable to violation of the instructions in this manual or operations in the manner not specified in this manual
- Any malfunction or damage attributable to any cause or causes beyond the reasonable control of HORIBA Advanced Techno Co., Ltd. such as natural disasters
- Any deterioration in appearance attributable to corrosion, rust, and so on
- Replacement of consumables

HORIBA Advanced Techno Co., Ltd. SHALL NOT BE LIABLE FOR ANY DAMAGES RESULTING FROM ANY MALFUNCTIONS OF THE PRODUCT, ANY ERASURE OF DATA, OR ANY OTHER USES OF THE PRODUCT.

Trademarks

Company names and brand names are either registered trademarks or trademarks of the respective companies. (R), (TM) symbols may be omitted in this manual.

Regulations

EU regulations

■ Conformable standards

This equipment conforms to the following standards:



EMC: EN61326-1
Class B, Portable test and measurement equipment
RoHS: EN50581
9. Industrial monitoring and control instruments

Warning: This product is not intended for use in industrial environments. In an industrial environment, electromagnetic environmental effects may cause the incorrect performance of the product in which case the user may be required to take adequate measures.

■ Information on disposal of electrical and electronic equipment and disposal of batteries and accumulators

The crossed out wheeled bin symbol with underbar shown on the product or accompanying documents indicates the product requires appropriate treatment, collection and recycle for waste electrical and electronic equipment (WEEE) under the Directive 2012/19/EU, and/or waste batteries and accumulators under the Directive 2006/66/EC in the European Union.

The symbol might be put with one of the chemical symbols below. In this case, it satisfies the requirements of the Directive 2006/66/EC for the object chemical.

This product should not be disposed of as unsorted household waste.

Your correct disposal of WEEE, waste batteries and accumulators will contribute to reducing wasteful consumption of natural resources, and protecting human health and the environment from potential negative effects caused by hazardous substance in products.

Contact your supplier for information on applicable disposal methods.

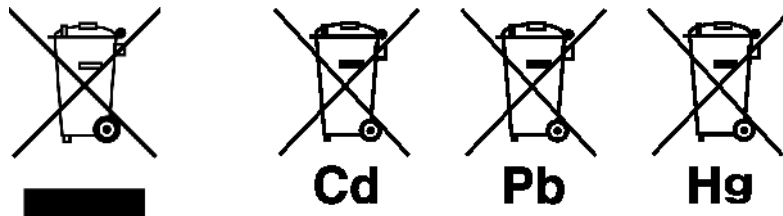

■ Authorised Representative in EU

HORIBA Europe GmbH
Hans-Mess-Str.6, D-61440 Oberursel, Germany

FCC rules

Any changes or modifications not expressly approved by the party responsible for compliance shall void the user's authority to operate the equipment.

■ Warning

This equipment has been tested and found to comply with the limits for a Class A digital device, pursuant to part 15 of the FCC Rules. These limits are designed to provide reasonable protection against harmful interference when the equipment is operated in a commercial environment. This equipment generates, uses, and can radiate radio frequency energy and, if not installed and used in accordance with the instruction manual, may cause harmful interference to radio communications.

Operation of this equipment in a residential area is likely to cause harmful interference in which case the user will be required to correct the interference at his own expense.

Korea certification

■ B급 기기 (가정용 방송통신기자재)

이 기기는 가정용(B 급) 전자파적합기기로서 주로 가정에서 사용하는 것을 목적으로 하며, 모든 지역에서 사용할 수 있습니다.

Taiwan battery recycling mark



廢電池請回收

For Your Safety

Hazard classification and warning symbols

Warning messages are described in the following manner. Read the messages and follow the instructions carefully.

■ Hazard classification



DANGER

This indicates an imminently hazardous situation which, if not avoided, will result in death or serious injury. This is to be limited to the most extreme situations.



WARNING

This indicates a potentially hazardous situation which, if not avoided, could result in death or serious injury.



CAUTION

This indicates a potentially hazardous situation which, if not avoided, may result in minor or moderate injury. It may also be used to alert against unsafe practices.

■ Warning symbols



Description of what should be done, or what should be followed



Description of what should never be done, or what is prohibited

Safety label list

The following table lists the labels attached on the product.

For more details, refer to the descriptions of the individual labels provided later in this manual.

Hazard level	Hazard type	Label ID number
WARNING	FALLING	3200647816

The following pages describe the safety information in German, French, Italian, Swedish, Spanish, Polish, Dutch, and Japanese (8 languages), and the safety labels affixed to the product (9 languages, including the above and English).

[DEU] Sicherheitsinformation

Lesen Sie vor der Verwendung des Produkts unbedingt diese Anleitung, um den ordnungsgemäßen und sicheren Betrieb des Produkts zu gewährleisten. Bewahren Sie die Anleitung sicher auf, damit sie bei Bedarf jederzeit zur Hand ist.

Die technischen Daten und das Erscheinungsbild des Produkts sowie der Inhalt dieser Anleitung können unangekündigt geändert werden.

■ Installationsumgebung

Dieses Produkt ist nicht zum Gebrauch in industriellen Umgebungen, wie in EN61326-1 definiert, vorgesehen.

In einer industriellen Umgebung können die elektromagnetischen Störungen eventuell zu Produktfehlfunktionen führen. Um dieses Produkt unter solchen Umständen verwenden zu können, muss der Benutzer ggf. angemessene Maßnahmen ergreifen.

■ Gefahrenklassifikation und Warnsymbole

Warnmeldungen werden wie folgt beschrieben. Lesen Sie die Meldungen und befolgen Sie die Anleitungen sorgfältig.



GEFAHR

Dies weist auf eine unmittelbar gefährliche Situation hin, die im Tod oder in schweren Verletzungen resultiert, falls sie nicht vermieden wird. Dies ist auf die extremsten Situationen zu begrenzen.



WARNUNG

Dies weist auf eine potentiell gefährliche Situation hin, die im Tod oder in schweren Verletzungen resultieren könnte, falls sie nicht vermieden wird.



VORSICHT

Dies weist auf eine potentiell gefährliche Situation hin, die in leichten oder mäßigen Verletzungen resultieren könnte, falls sie nicht vermieden wird. Sie kann auch zur Warnung vor unsicheren Praktiken verwendet werden.

■ Liste der Sicherheitsschilder

Die folgende Tabelle listet die am Produkt befestigten Schilder auf.

Weitere Details entnehmen Sie den Beschreibungen der individuellen Schilder weiter hinten in dieser Anleitung.

Gefahrenstufe	Gefahrentyp	Schild-ID-Nummer
WARNUNG	HINFALLEN	3200647816

[FRA] Informations de sécurité

Veillez à lire le présent manuel avant d'utiliser le produit de manière à garantir son utilisation correcte et sûre. De même, rangez le manuel dans un lieu sûr de manière à pouvoir vous y reporter lorsque cela est nécessaire.

Les spécifications et l'aspect du produit, ainsi que le contenu du présent manuel peuvent être modifiés sans notification préalable.

■ Environnement d'installation

Ce produit n'est pas destinés à une utilisation dans des environnements industriels, tels que définis dans la norme EN61326-1.

Dans un environnement industriel, les interférences électromagnétiques peuvent entraîner un dysfonctionnement du produit. Pour utiliser le produit dans ce type d'environnements, l'utilisateur peut avoir à prendre des mesures appropriées.

■ Classification des risques et symboles d'avertissement

Les messages d'avertissement sont décrits comme suit. Lisez les messages et suivez attentivement les instructions.



DANGER

Cela indique une situation dangereuse imminente qui, si elle n'est pas évitée, entraînera la mort ou des blessures graves. Cela fait uniquement référence aux situations les plus extrêmes.



AVERTISSEMENT

Cela indique une situation potentiellement dangereuse qui, si elle n'est pas évitée, peut entraîner la mort ou des blessures graves.



ATTENTION

Cela indique une situation potentiellement dangereuse qui, si elle n'est pas évitée, peut entraîner des blessures mineures ou modérées. Cela peut également être utilisé pour signaler des pratiques dangereuses.

■ Liste des étiquettes de sécurité

Le tableau suivant répertorie les étiquettes fixées sur le produit.

Pour plus de détails, reportez-vous aux descriptions des étiquettes individuelles fournies ultérieurement dans ce manuel.

Niveau de risque	Type de risque	Numéro d'identification de l'étiquette
AVERTISSEMENT	CHUTE	3200647816

[ITA] Informazioni sulla sicurezza

Leggere attentamente questo manuale prima di utilizzare il prodotto al fine di utilizzarlo in modo sicuro e adeguato. Inoltre, conservare in un luogo sicuro il manuale per poterlo consultare se necessario.

Le specifiche e l'aspetto del prodotto, nonché i contenuti di questo manuale, sono soggetti a modifica senza preavviso.

■ Ambiente di installazione

Questo prodotto non è stato progettato per essere utilizzato in ambienti industriali, secondo la norma EN61326-1.

In un ambiente industriale, le interferenze elettromagnetiche potrebbero causare un malfunzionamento del prodotto. Per utilizzare il prodotto in tali ambienti, all'utente potrebbe essere richiesto di adottare le contromisure necessarie.

■ Categoria di pericolo e simboli di avvertenza

I messaggi di avvertenza sono descritti come segue. Leggere i messaggi e seguire con attenzione le istruzioni.



PERICOLO

Indica un pericolo immediato che, se non evitato, può causare il decesso o lesioni gravi. Limitato alle situazioni più estreme.



AVVERTENZA

Indica una situazione potenzialmente pericolosa che, se non evitata, potrebbe causare il decesso o lesioni gravi.



ATTENZIONE

Indica una situazione potenzialmente pericolosa che, se non evitata, potrebbe causare lesioni di media e piccola entità. Potrebbe essere usato anche per informare circa pratiche non sicure.

■ Elenco etichette di sicurezza

La tabella seguente elenca le etichette applicate sul prodotto.

Per maggiori informazioni, consultare la descrizione di ciascuna etichetta più avanti nel presente manuale.

Livello di pericolo	Tipo di pericolo	Numero ID etichetta
AVVERTENZA	CADUTA	3200647816

[SWE] Säkerhetsinformation

Se till att du läser denna handbok innan du börjar använda produkten för en korrekt och säker användning av den. Spara sedan handboken på en säker och lättåtkomlig plats så att du kan konsultera den när så behövs.

Produktspecifikationerna och utseendet, samt även innehållet i denna handbok, kan komma att ändras utan föregående meddelande därom.

■ Installationsmiljö

Detta produkten är ej avsedda för användning i industriella miljöer enligt riktlinjerna i EN61326-1.

Om den används i industrimiljöer kan de elektromagnetiska störningarna orsaka tekniska fel hos produkten. Om produkten ska användas i sådana miljöer kan användaren behöva vidta lämpliga åtgärder för att lösa dessa problem.

■ Riskklassificering och varningssymboler

Varningsmeddelandena beskrivs på följande sätt. Läs meddelandena och följ anvisningarna noggrant.



FARA

Denna varnar för en omedelbart risksituation som kan orsaka allvarliga personskador eller dödsfall om den inte följs. Detta omfattar endast de mest extrema situationerna.



VARNING

Denna varnar för en potentiell risksituation som kan orsaka allvarliga personskador eller dödsfall om den inte följs.



OBSERVER

Denna varnar för en potentiell risksituation som kan orsaka mindre person- eller materialskador om den inte följs. Den kan även användas för att indikera olämplig användning.

■ Lista över säkerhetsetiketter

I följande tabell listas de etiketter som sitter fastsatta på produkten.

Läs beskrivningarna för varje enskild etikett som finns längre fram i handboken för mer information.

Risknivå	Risktyp	Etikett-ID-nummer
VARNING	FALLANDE	3200647816

[SPA] Información de seguridad

Asegúrese de leer este manual antes de utilizar el producto para garantizar un uso correcto y seguro del mismo. Asimismo, guarde de forma segura el manual para que esté disponible siempre que sea necesario.

El aspecto y las especificaciones del producto, así como el contenido de este manual, están sujetos a cambios sin previo aviso.

■ Entorno de instalación

Este producto está diseñado para su uso en entornos industriales, tal y como se define en EN61326-1.

En un entorno industrial, las interferencias electromagnéticas pueden provocar un funcionamiento incorrecto del producto. Para usar el producto en tales entornos, el usuario debe tomar las medidas adecuadas.

■ Clasificación de peligrosidad y símbolos de advertencia

Los mensajes de advertencia se describen de la siguiente manera. Lea los mensajes y siga las instrucciones atentamente.



PELIGRO

Esto indica una situación de peligro inminente que, si no se evita, tendrá como resultado la muerte o lesiones graves. Esto se debe limitar a las situaciones más extremas.



ADVERTENCIA

Esto indica una posible situación de peligro que, si no se evita, podría tener como resultado la muerte o lesiones graves.



ATENCIÓN

Esto indica una posible situación de peligro que, si no se evita, puede tener como resultado lesiones leves o moderadas. También se puede usar para alertar de prácticas no seguras.

■ Lista de etiquetas de seguridad

En la siguiente tabla se muestran las etiquetas adheridas al producto.

Para obtener más información, consulte las descripciones de las etiquetas individuales que se proporcionan más adelante en este manual.

Nivel de riesgo	Tipo de riesgo	Número de ID de etiqueta
ADVERTENCIA	CAÍDA	3200647816

[POL] Informacje dotyczące bezpieczeństwa

Przed przystąpieniem do użytkowania tego produktu należy dokładnie zapoznać się z niniejszą instrukcją, aby zapewniona była prawidłowa i bezpieczna eksploatacja produktu. Instrukcję przechowywać w bezpiecznym miejscu, aby w razie potrzeby była zawsze dostępna.

Specyfikacja i wygląd produktów oraz treść niniejszej instrukcji może ulec zmianie bez wcześniejszego powiadomienia.

■ Środowisko instalacji

Ten produkt nie są przeznaczone do użytkowania w środowisku przemysłowym, zgodnie z definicją określoną w normie EN61326-1.

W środowisku przemysłowym zakłócenia elektromagnetyczne mogą powodować nieprawidłowe działanie produktów. Możliwe, że aby użytkować produkt w takich środowiskach, użytkownik będzie musiał podjąć stosowne środki zaradcze.

■ Klasyfikacja zagrożeń i symbole ostrzegawcze

Ostrzeżenia są opisane w następujący sposób. Należy zapoznać się z ostrzeżeniami i ściśle przestrzegać instrukcji.



NEBEZPIECZEŃSTWO

Oznacza bezpośrednio niebezpieczną sytuację, która — jeśli do niej dojdzie — spowoduje zgon lub poważne obrażenia ciała. To ostrzeżenie dotyczy najbardziej skrajnych sytuacji.



OSTRZEŻENIE

Oznacza potencjalnie niebezpieczną sytuację, która — jeśli do niej dojdzie — może spowodować zgon lub poważne obrażenia ciała.



PRZESTROGA

Oznacza potencjalnie niebezpieczną sytuację, która — jeśli do niej dojdzie — może spowodować niewielkie lub umiarkowane obrażenia ciała. Ten rodzaj ostrzeżenia może także być używany do ostrzegania przed niebezpiecznymi sposobami postępowania.

■ Lista etykiet bezpieczeństwa

W poniższej tabeli wymieniono etykiety umieszczone na produkcie.

Bardziej szczegółowe informacje można znaleźć w opisach poszczególnych etykiet, które znajdują się w dalszej części niniejszej publikacji.

Poziom zagrożenia	Typ zagrożenia	Numer identyfikacyjny etykiety
OSTRZEŻENIE	UPADEK	3200647816

[NLD] Veiligheidsinformatie

Lees deze handleiding voordat u dit product gebruikt zodat u het op de juiste manier en veilig kunt gebruiken. Bewaar de handleiding goed zodat u hem wanneer nodig kunt raadplegen.

De specificaties en het uiterlijk van het product en de inhoud van deze handleiding kunnen zonder voorafgaande kennisgeving worden gewijzigd.

■ Installatieomgeving

Dit product is niet bedoeld voor gebruik in een industriële omgeving zoals gedefinieerd in EN 61326-1.

In een industriële omgeving kan de elektromagnetische interferentie de werking van dit product storen. Voor gebruik van het product in een dergelijke omgeving moet de gebruiker mogelijk maatregelen treffen om de storing te verhelpen.

■ Indeling naar gevarencategorie en waarschuwingssymbolen

De waarschuwingen hebben de volgende betekenis. Lees de uitleg en volg de instructies aandachtig.



GEVAAR

Dit wijst op een onmiddellijk gevaarlijke situatie die zal leiden tot dodelijk of ernstig letsel als die niet wordt vermeden. Dit wordt alleen in de meest extreme gevallen gebruikt.



WAARSCHUWING

Dit wijst op een mogelijk gevaarlijke situatie die kan leiden tot dodelijk of ernstig letsel als die niet wordt vermeden.



VOORZICHTIG

Dit wijst op een mogelijk gevaarlijke situatie die kan leiden tot klein of matig letsel als die niet wordt vermeden. Dit kan ook gebruikt worden als waarschuwing tegen onveilig gebruik.

■ Lijst van veiligheidslabels

In de volgende tabel worden de labels vermeld die op het product zijn aangebracht.

Raadpleeg voor meer details de beschrijving van de afzonderlijke labels verder in deze handleiding.

Risiconiveau	Risicotype	ID-nummer van label
WAARSCHUWING	VALLEN	3200647816

[JPN] 安全情報

ご使用になる前に、本書を必ずお読みください。お読みになった後は必要なときにすぐに取り出せるように大切に保管してください。

ご使用の際、安全に関してお気付きの点がありましたら、弊社にご連絡ください。

製品の仕様・外観は、改良のため予告なく変更することがあります。

また、本書に記載されている内容も予告なく変更される場合があります。あらかじめご了承ください。

■ 設置環境

本製品は、EN61326-1で定義される工業環境で使用することを想定した製品ではありません。工業環境においては、電磁妨害の影響を受ける可能性があり、その場合には使用者が適切な対策を講ずることが必要となる場合があります。

■ 警告の種類と表示方法

本書および製品では、以下のような警告表示をしています。内容をよく理解して、正しく安全にご使用ください。



危険

取り扱いを誤った場合、使用者が死亡または重傷を負うことがあり、かつその切迫の度合いが高いもの



警告

取り扱いを誤った場合、使用者が死亡または重傷を負う可能性が想定されるもの



注意

取り扱いを誤った場合、使用者が傷害を負うことが想定されるか、または物的損害の発生が想定されるもの

■ 安全ラベル一覧

製品には以下の安全ラベルが貼り付けられています。

安全ラベルの内容については、後述の各ラベルの説明を参照してください。

危険レベル	危険の種類	ラベル識別番号
警告	落下	3200647816

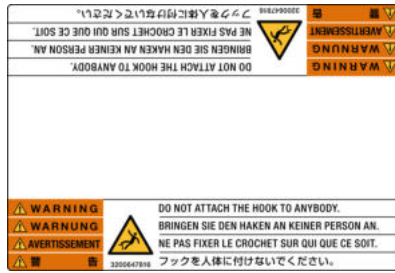

3200647816

[ENG]	
WARNING	FALLING Do not attach the hook to the body.
FALLING	The probe may be caught by a strong current and you may fall into the water. In addition, if the distance to the water surface is large or the flow is fast, attach the hook to a place where it can be fastened firmly.
[DEU]	
WARNUNG	HINFALLEN Bringen Sie den Haken nicht am Körper an. Die Sonde kann von einem starken Strom erfasst werden und Sie können in das Wasser fallen.
HINFALLEN	Wenn außerdem der Abstand zur Wasseroberfläche groß ist oder die Strömung schnell ist, bringen Sie den Haken an einem Ort an, wo er sicher befestigt werden kann.
[FRA]	
AVERTISSEMENT	CHUTE Ne pas fixer le crochet au corps. La sonde peut être prise dans un fort courant et vous pouvez tomber à l'eau.
CHUTE	En outre, si la distance jusqu'à la surface de l'eau est grande ou que le courant est rapide, fixer le crochet à un endroit où il peut être fixé fermement.
[ITA]	
AVVERTENZA	CADUTA Non fissare il gancio al corpo. La sonda può essere catturata da una forte corrente e si può cadere in acqua.
CADUTA	Inoltre, se la distanza dalla superficie dell'acqua è grande o il flusso è veloce, ancorare il gancio in un luogo in cui può essere fissata saldamente.

<p>FALLANDE Fäst inte kroken i kroppen. Sonden kan dras med av en stark ström och du kan falla i vattnet. Fäst dessutom kroken på en plats där den kan fästas ordentligt om avståndet till vattenytan är stort eller flödet är stritt.</p>	[SWE]
	VARNING
	FALLANDE
<p>CAÍDA No coloque el gancho en el cuerpo. La sonda podría quedar atrapada en una corriente fuerte y podría caerse al agua. Además, si la distancia a la superficie del agua es grande o si la corriente es rápida, coloque el gancho en un lugar donde quede sujeto firmemente.</p>	[SPA]
	ADVERTENCIA
	CAÍDA
<p>UPADEK Nie mocować haka do ciała. Sonda może zostać pochwycona przez silny prąd i spowodować upadek użytkownika do wody. Ponadto, jeśli odległość do powierzchni wody jest duża lub przepływ jest szybki, zaczepić hak w miejscu, gdzie może zostać solidnie zamocowany.</p>	[POL]
	OSTRZEŻENIE
	UPADEK
<p>VALLEN Verbind de haak niet met het lichaam. De sonde kan worden opgevangen door een sterke stroming en u kunt in het water vallen. Daarnaast, als de afstand tot het wateroppervlak groot is of de stroom snel, bevestig dan de haak aan een plaats waar deze stevig kan worden vastgezet.</p>	[NLD]
	WAARSCHUWING
	VALLEN
<p>落下注意 フックを人体に取り付けしないでください。 流れに巻き込まれて落下するおそれがあります。 また、水面までの落差が大きい場合や流速が速い場合は、しっかり固定できる場所に取り付けてください。</p>	[JPN]
	警告
	落下

Safety precautions

This section provides precautions for using the product safely and correctly and to prevent injury and damage. The terms of DANGER, WARNING, and CAUTION indicate the degree of imminency and hazardous situation. Read the precautions carefully as it contains important safety messages.



WARNING



Do not disassemble or modify the meter.
May cause overheating or fire, resulting in accidents.



CAUTION



The pH and ORP sensors are made of glass. Handle them carefully to avoid breakage.



Do not ingest the DO, pH or ORP standard solutions.
If it comes into contact with the eyes, rinse thoroughly with water. If swallowed, consult a physician.



Keep away from water when using USB communication. Improper use may result in fire or damage.

Product Handling Information

Operational precautions

Use of the product in a manner not specified by the manufacturer may impair the protection provided by the product. And it may also reduce product performance.

Exercise the following precautions:

■ General

- Only use the product including accessories for their intended purpose.

■ Sensor probe

- After seawater measurement, promptly wash the sensor probe thoroughly in water.
- Do not immerse the sensor probe in alcohol, organic solvent, strong acid, strong alkaline, and other similar solutions.
- Do not subject to strong shocks.
- Do not perform measurement in environments of magnetic fields. Measurement errors may result.
- The sensor probe is no longer waterproof when the sensors are not mounted.

Appearance of mounted sensors

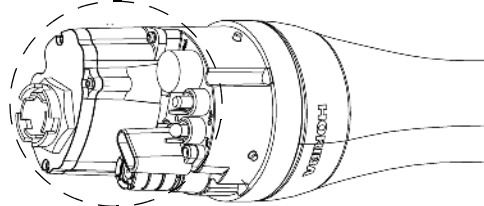

- Does not support measurement of samples containing fluorine.
- Do not mistake the combination of sensor probe and turbidity sensor.
- To disconnect the sensor cable or interface cable, pull them out with holding the connector part. Do not pull the cable part; it may cause breakage.

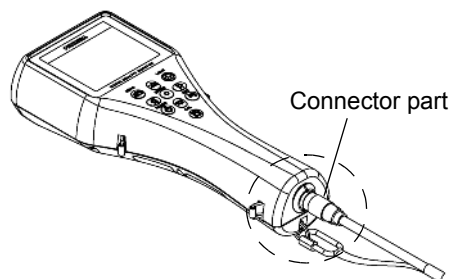

- Sensor probe of U-54 and U-54G cannot be used with the conventional control unit. Unusable control units are following version.
P2000266001D, P2000266001C, P2000266001B, P2000266001A, P2000266001-
To confirm the version, see "● Version" (page 35).

Control unit

- Do not subject to strong shocks.
- The operation keys are designed to operate using the pad of a finger, sharp objects can tear the control unit cover damaging the operation keys.

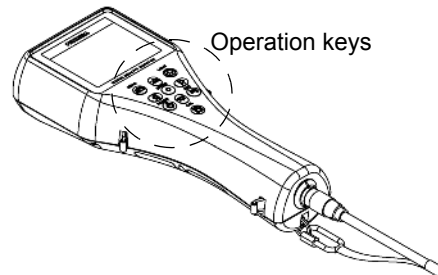

- The control unit is no longer waterproof when the USB cable is connected.
- When operating the control unit only, protect the connector with the connector cap provided.
- Remove the batteries when not using the control unit for an extended period of time. Battery fluid leakage may cause equipment failure.
- Do not wipe the control unit with organic solvents or powder polish. The surface may deteriorate or its printing may disappear. If the display becomes dirty, wipe the dirt off with a soft cloth soaked in neutral detergent.
- Do not turn the power OFF or disconnect the cable during calibration or setting. Memory data may be erased.
- To perform measurement, connect the sensor probe cable before turning the power ON.
- Do not remove the battery gasket or twist it.
- When opening the battery case, make sure that no foreign matter is attached to the battery gasket.
- Do not use any unspecified batteries; it may cause breakage.

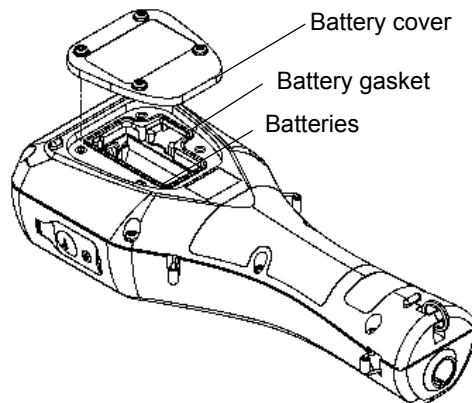

■ Measurement

- Before lowering the sensor probe into the sample, do not connect the hook on the unit to a human body.
- The correct values are not displayed if the sensor is not mounted when the measurement display is activated.
- Perform DO measurement with no air bubbles in the internal solution.
- Do not reuse a membrane cap of DO sensor.
- Use the spanner for DO sensor provided to attach or remove the DO sensor.
- Avoid both U-53 and U-53G turbidity measurement in air, since the rubber wiper will quickly become damaged.
- Attach sensor guard to sensor probe in the measurement. When sensor probe is used in calibration cups (black and transparent) or flow cell, the sensor guard can be taken off.

■ Calibration

During atmosphere calibration for the DO electrode with DO salinity compensation set to automatic, values are compensated based on electrical conductivity, but calibration is performed normally.

Location of use and storage

- Storage temperature: -10°C to 60°C
- Relative humidity: Under 80% and free from condensation

Store the meter in locations void of dust, strong vibrations, direct sunlight, corrosive gases, near air conditioners or windy areas.

Disposal of the product

When disposing of the product, follow the related laws and/or regulations of your country.

Manual Information

Description in this manual

Note

This interprets the necessary points for correct operation and notifies the important points for handling the product.

Reference

This indicates the part where to refer for information.

Tip

This indicates reference information.

Original language

This is the English translation of an original Japanese document.

Contents

1	About this Unit	1
2	Device Information	2
2.1	Measurement parameters	2
2.2	Packing list	3
2.3	Parts name and functions	4
2.4	Setting menu items	7
2.5	Calibration menu items	7
2.6	Data operation menu items	7
3	Basic Operation	8
3.1	System setup	8
3.1.1	Inserting and replacing the batteries	8
3.1.2	Replacing the coin battery	10
3.1.3	Attaching sensors	11
3.1.4	Connecting the control unit and sensor probe	14
3.1.5	Conditioning	14
3.1.6	GPS (U-52G, U-53G, U-54G)	15
3.2	Settings	18
3.2.1	Setting measurement methods	18
3.2.2	Setting sites	20
3.2.3	Unit for report	23
3.2.4	Sensor selection	25
3.2.5	Compensation	26
3.2.6	System settings	34
3.3	Calibration	41
3.3.1	Auto calibration	41
3.3.2	Manual calibration	44
3.4	Measurement	63
3.4.1	Storing data in memory manually	63
3.4.2	Automatic, continuous measurement	65
3.5	Data operations	66
3.5.1	Displaying data	66
3.5.2	Deleting data	70
3.5.3	Checking the data memory	71
3.5.4	Checking the calibration record	72
3.5.5	GPS data operations	73
3.6	Sensor information	74
3.7	USB communication	75
3.7.1	Communication settings	75

3.7.2	Commands	76
4	Maintenance	84
4.1	Contact for maintenance	84
4.2	Routine care	84
4.3	Every 2 months maintenance	86
4.4	Storage	87
4.5	Replacing the turbidity sensor	88
4.6	Replacing the membrane cap	89
4.7	Troubleshooting	91
4.7.1	Error displays	91
4.7.2	Error displays in sensor information	96
5	Specifications	97
6	Reference	101
6.1	Consumable parts	101
6.2	Options sold separately	102
6.3	pH measurement	103
6.3.1	Principle of pH measurement	103
6.3.2	Temperature compensation	103
6.3.3	Standard solutions	103
6.4	DO measurement	105
6.4.1	Principle of DO measurement	105
6.4.2	Conditioning of DO sensor	105
6.4.3	Salinity calibration	106
6.4.4	Atmospheric pressure compensation (DO) - Relation of altitude and air pressure	107
6.5	Conductivity (COND) measurement	110
6.5.1	Four-AC-electrode method	110
6.5.2	SI units	111
6.5.3	Temperature coefficient	111
6.6	Salinity (SAL) conversion	113
6.7	TDS conversion	113
6.8	σ_t conversion	113
6.9	Turbidity (TURB) measurement	114
6.9.1	Principle of turbidity measurement	114

6.9.2	Standard solution	114
6.10	Depth (DEPTH) measurement	115
6.10.1	Principle of depth measurement	115
6.10.2	Influence of temperature and calibration	115
6.11	Oxidation reduction potential (ORP) measurement	115
6.11.1	Principle of ORP measurement	115
6.11.2	Standard electrode (reference electrode) types and ORP	116

1 About this Unit

The U-50 Series Multi Water Quality Checker features an integrated control unit and sensors. It is capable of making a maximum of eleven simultaneous measurements for various parameters, and is perfect for use in the field. The U-50 Series is designed with on-site ease-of-use in mind, provides a wide variety of functions, and can be used for water quality measurements and inspections of river water, groundwater, and waste water.

2 Device Information

2.1 Measurement parameters

Parameters	Model						
	U-51	U-52	U-52G	U-53	U-53G	U-54	U-54G
pH (pH)	✓	✓	✓	✓	✓	✓	✓
pH (mV)	✓	✓	✓	✓	✓	✓	✓
Oxidation reduction potential (ORP)	✓	✓	✓	✓	✓	✓	✓
Dissolved oxygen (DO)	✓	✓	✓	✓	✓	✓	✓
Electrical conductivity (COND)	✓	✓	✓	✓	✓	✓	✓
Salinity (SAL) [expressed as electrical conductivity]	✓	✓	✓	✓	✓	✓	✓
Total dissolved solids (TDS) [expressed as electrical conductivity]	✓	✓	✓	✓	✓	✓	✓
Seawater specific gravity (SG) [expressed as electrical conductivity]	✓	✓	✓	✓	✓	✓	✓
Water temperature (TEMP)	✓	✓	✓	✓	✓	✓	✓
Turbidity (TURB) [LED transmission/front 30° scattering method]	–	✓	✓	–	–	–	–
Turbidity (TURB) [tungsten lamp 90° transmission/scattering method] with wiper	–	–	–	✓	✓	–	–
Turbidity (TURB) [LED 90° transmission/scattering method]	–	–	–	–	–	✓	✓
Water depth (DEP)	–	–	✓	✓	✓	2 m: –	2 m: –
						10 m, 30 m: ✓	10 m, 30 m: ✓
GPS	–	–	✓	–	✓	–	✓

"✓" indicates a measurable parameter.

2.2 Packing list

Parts Name	Quantity	Note
Control unit	1	
Sensor probe	1	
pH sensor (#7112)	1	
ORP sensor (#7313)	1	
Reference electrode (#7210)	1	
DO sensor (#7543)	1	
Turbidity sensor (#7800)	1	With U-52/U-52G only. Attached to the sensor probe.
Turbidity sensor (#7801)	1	With U-53/U-53G only. Attached to the sensor probe.
Turbidity sensor (#7802)	1	With U-54/U-54G only. Attached to the sensor probe.
pH 4 standard solution (#100-4)	1	500 mL
pH reference internal solution (#330)	1	250 mL
DO sensor internal solution set (#306)	1	Internal solution (50 mL), Sandpaper (#8000, #600), Syringe
DO Membrane spare parts set	1	
Spanner for DO sensor	1	
Cleaning brush	1	
calibration cup	1	transparent calibration cup, black calibration cup
Back pack	1	
Strap	1	
Alkaline batteries	4	LR14
Silicon grease	1	
Instruction manual	1	

2.3 Parts name and functions

● Display

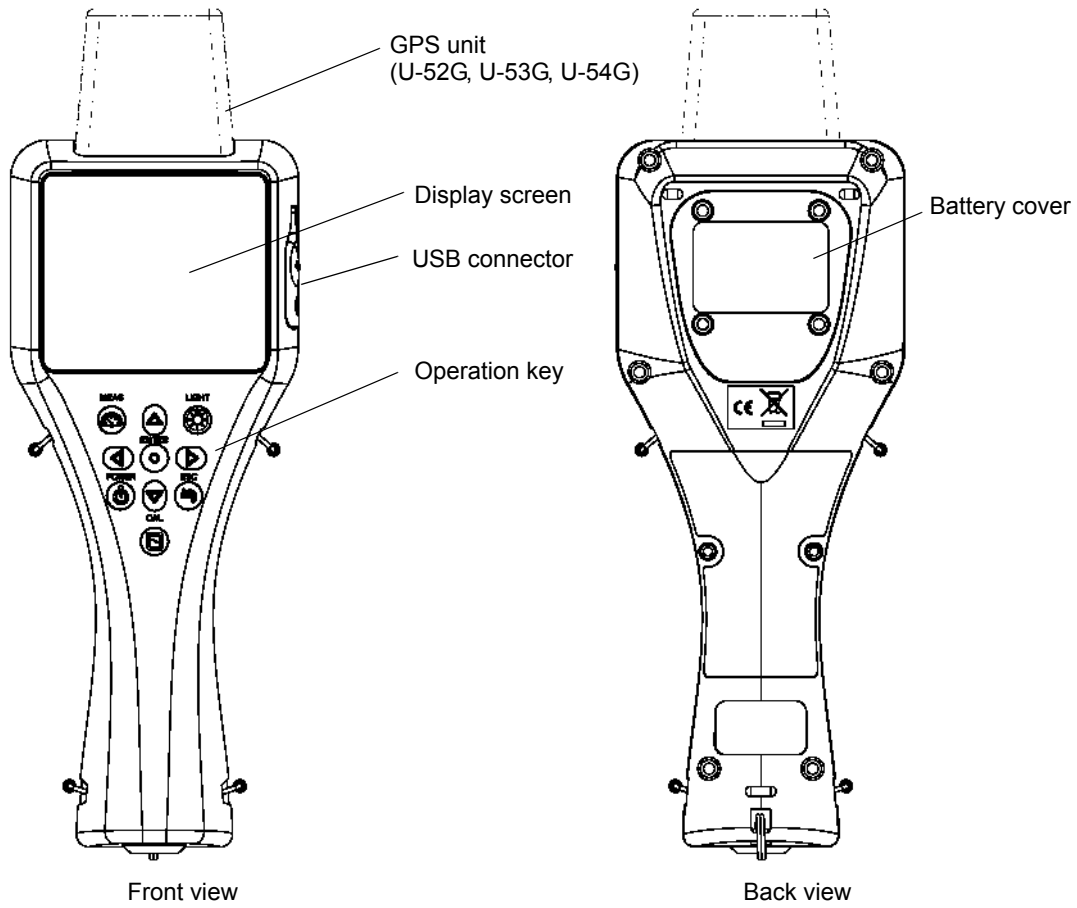

● Sensor probe (U-51)

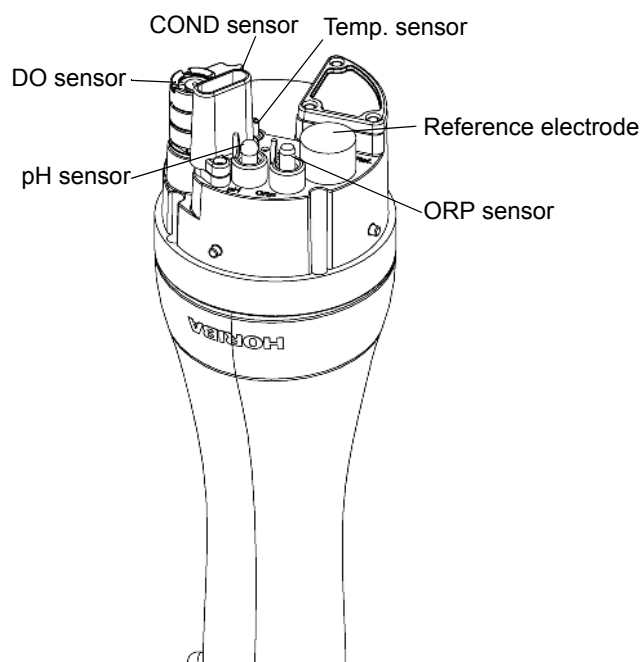

● **Sensor probe (U-52)**

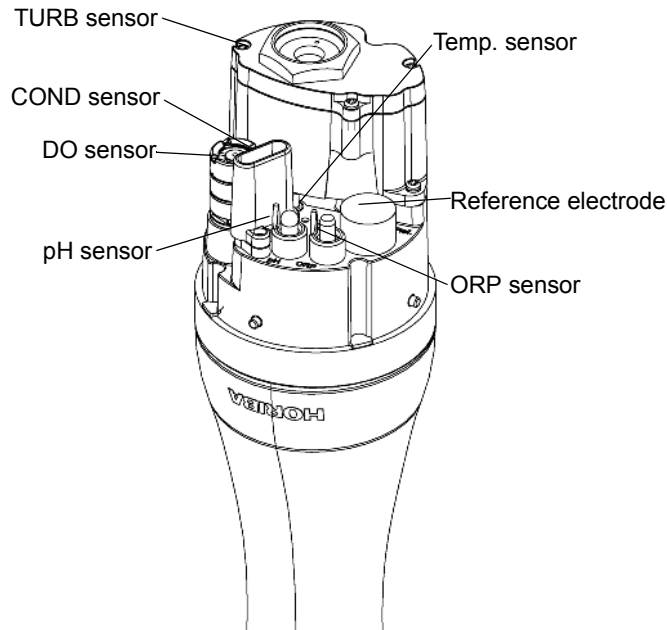

● **Sensor probe (U-53, U-54)**

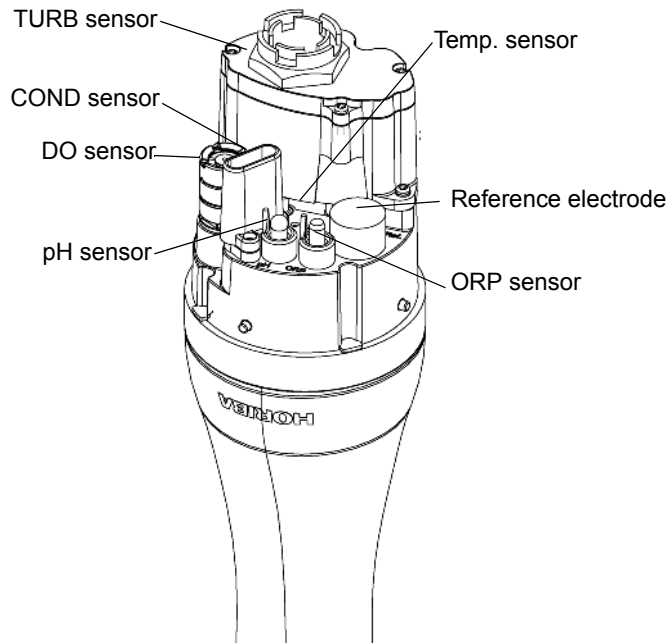











● **Display screen**

YYYYY/MM/DD Time
 GPS reception
 USB connection status
 Sensor probe connection status
 Battery level
 Level 3 Sufficient power remaining
 Level 2 Remaining power does not affect operation
 Level 1 Batteries need replacing
 Operation guidance

2008/12/02 14:27:46	SINGLE MEASUREMENT	
SITE:		
25.23 °C	7.82 mg/L DO	
6.99 pH	96.8 % DO	
-1 pHmV	0.293 g/L TDS	
121 ORPmV	0.1 ppt	
0.450 mS/cm	0.0 σt	
0.00 NTU	0.00 m	
Press MEAS to collect data.		

● Operation key

	Key name	description
<p>POWER</p> 	POWER key	Turns the system's power ON/OFF. The initial screen appears immediately after turning the power ON. Press the POWER key for about 1 second to turn the power ON and OFF.
<p>MEAS</p> 	MEAS key	When pressed in the measurement screen, used to set the measurement values of all the measurement parameters. Measurement values flash until the data stabilizes. When pressed in the setting, calibration or data operation screen, returns to the measurement screen.
<p>ENTER</p> 	ENTER key	Used to execute functions, set entered values or store data in memory. Used to change the size of measurement value.
<p>CAL</p> 	CAL key	When pressed in the measurement screen, switches to the calibration screen.
<p>ESC</p> 	ESC key	Returns to the immediately preceding operation. Used to stop measurement.
<p>LIGHT</p> 	LIGHT key	Turns the backlight ON/OFF. <ul style="list-style-type: none"> ● Using the backlight shortens battery life. ● The backlight does not light for about 3 seconds after power ON. ● When the sensor probe is connected while the display's backlight is lit, the backlight goes out for about 3 seconds.
	Left key	Moves the cursor to the left.
	Right key	Moves the cursor to the right.
	Up key	Moves the cursor up.
	Down key	Moves the cursor down.

2.4 Setting menu items

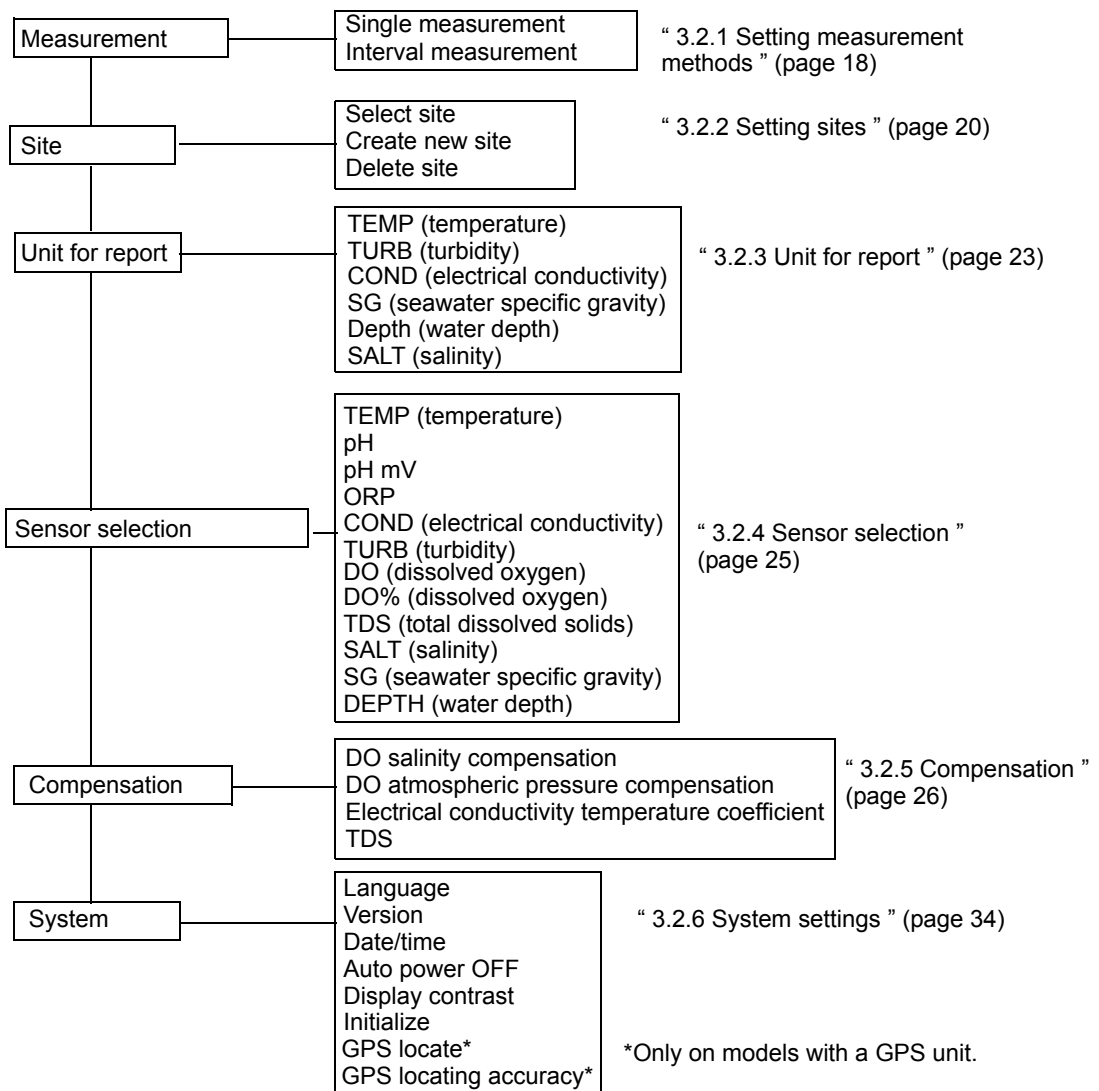

2.5 Calibration menu items

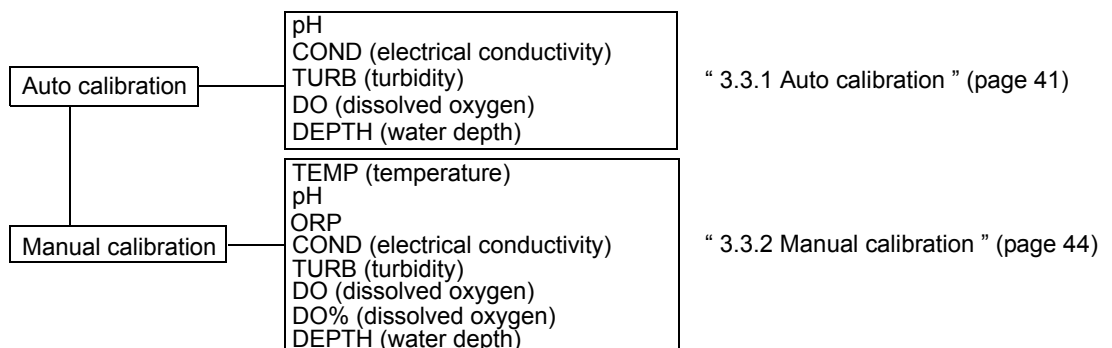

2.6 Data operation menu items

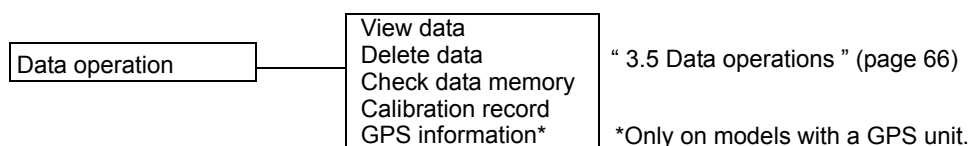

3 Basic Operation

3.1 System setup

3.1.1 Inserting and replacing the batteries

The control unit is shipped without batteries. Follow the steps below to insert the batteries when using the system for the first time or replacing old batteries.

1. Loosen the 4 screws on the battery cover by using No. 2 Phillips head screwdriver and remove the cover.

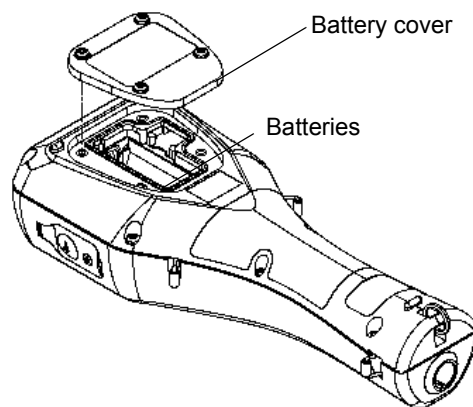

2. If replacing the batteries, discard the old batteries.
3. Insert new batteries in the control unit.
Check that the battery gasket is not dirty or twisted.

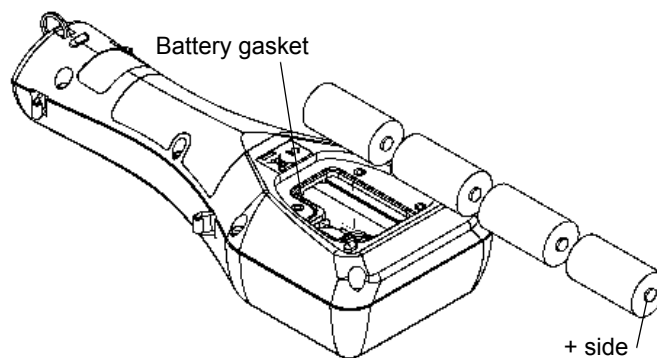

4. Replace the battery cover and fasten it with the 4 screws.
Tighten the screws to less than 0.5 N·m.

Note

- Data and settings will not be lost when the batteries are replaced.
- If dirty or twisted, the battery gasket will fail to keep the batteries dry. Check its condition before closing the cover.
- To ensure long service life, replacing the battery gasket periodically (once a year) is recommended.

Precautions when using dry cell batteries

- Batteries to use: LR14 alkaline dry cell batteries (C-size dry cell batteries) or rechargeable nickel-metal hydride dry cell batteries (C-size)
Do not use manganese batteries.
 - Dry cell batteries used incorrectly may leak or burst. Always observe the following
 - Orient the batteries correctly (positive and negative ends in correct positions).
 - Do not combine new and used batteries, or batteries of different types.
 - Remove the batteries when not using the system for a prolonged period.
 - If batteries leak, have the system inspected at your nearest sales outlet.
-

● Battery life

- The battery life for continuous operation when using C-size alkaline dry cell batteries is about 70 hours.
- Using the backlight consumes a proportionate amount of battery power, shortening battery life.
- Searching position information using the GPS unit consumes a proportionate amount of battery power, shortening battery life.
- Nickel-metal hydride secondary batteries can be used, but the battery life is not guaranteed since it will vary according to usage (number of times data is saved, number of charges and amount of each charge). In general, secondary batteries have one-half to one-third the life of C-size alkaline batteries.
- The 70-hour battery life figure applies to a control unit operating temperature of 20°C or more. The battery characteristics shorten the battery life at operating temperatures lower than 20°C, so check the remaining battery level, and replace the batteries before it reaches Level 1.
- The batteries packed with the system at the time of shipment are for checking operation. Their life is not guaranteed.
- The 70-hour battery life figure is the amount of operating time the batteries can provide until the system stops operating. The system may fail during operation if the remaining battery level is low, so it is a good idea to check the remaining battery level and replace the batteries with new ones well before the batteries run out completely.

U-51/52/54

Battery life: 70 hours (backlight off)

U-53

Battery life: 500 measurements (backlight off)

- Since U-53 is designed for turbidity measurement with wiper, its battery life is estimated in terms of the number of turbidity measurement sequences performed.
- Battery power is also consumed by measurement operations other than turbidity measurement.
- The battery life when turbidity measurement is not performed is about 70 hours.

3.1.2 Replacing the coin battery

- Coin battery to use: CR-2032
- The coin battery is only for the clock. It will provide problem-free operation for three years, but when using the clock continuously, it should be replaced every two years as a precaution.
- When replacing the coin battery for the clock, leave the control unit ON. If the coin battery is replaced when the control unit is turned OFF, the clock will be reset to the default settings.

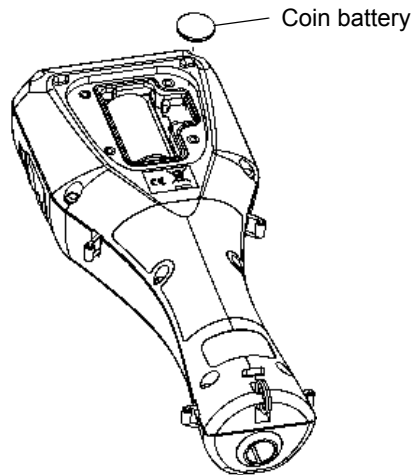

3.1.3 Attaching sensors

Note

- When attaching or replacing a sensor, wipe any moisture off the sensor probe and sensor.
- Be sure to keep water out of sensor connectors. If moisture comes in contact with a sensor connector, blow-dry it with dry air.
- The sensor probe is not waterproof when the sensor is not mounted.
- Take care not to tighten the sensor too much.

● Attaching the pH sensor

1. Remove the sensor guard.

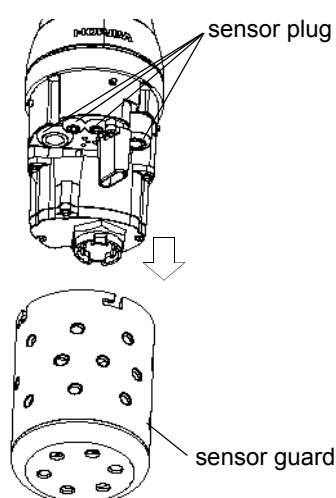

2. Remove the sensor plug.
3. Coat the pH sensor O-ring with a thin layer of silicon grease (part No. 3014017718).

Note

Be sure no grease from the O-ring gets on the sensor connector. If the sensor connector gets grease on it, wipe it off with a soft cloth soaked in alcohol.

4. Make sure there is no moisture on the sensor probe's sensor connector (marked "pH").
5. Fasten the pH sensor securely by hand.

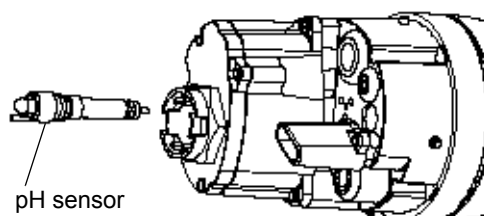

6. Clean the sensor with an alcohol-soaked cloth.

Note

Do not throw away the black cap which has been put on the tip of the sensor. It will be used for the storage.

● **Attaching the ORP sensor**

1. Remove the sensor guard.
2. Remove the sensor plug.
3. Coat the ORP sensor O-ring with a thin layer of grease (part No. 3014017718).

Note

Be sure no grease from the O-ring gets on the sensor connector. If the sensor connector gets grease on it, wipe it off with a soft cloth soaked in alcohol.

4. Make sure there is no moisture on the sensor probe's sensor connector (marked "ORP").
5. Fasten the ORP sensor securely by hand.

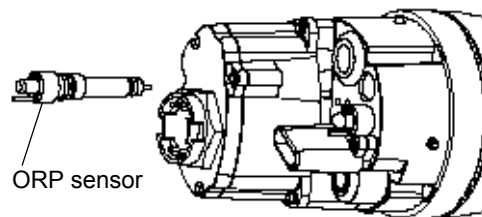

6. Clean the sensor with an alcohol-soaked cloth.

● **Attaching the reference electrode**

1. Remove the sensor guard.
2. Remove the sensor plug.
3. Coat the reference electrode O-ring with a thin layer of grease (part No. 3014017718).

Note

Be sure no grease from the O-ring gets on the sensor connector. If the sensor connector gets grease on it, wipe it off with a soft cloth soaked in alcohol.

4. Make sure there is no moisture on the sensor probe's sensor connector (marked "REF").
5. Fasten the reference electrode securely by hand.
6. Remove the tape from the liquid junction part of the reference electrode.

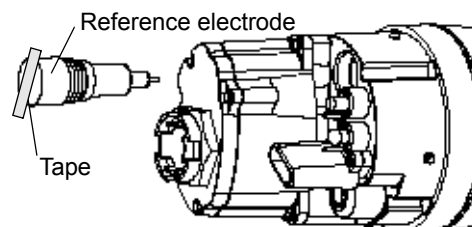

● Attaching the dissolved oxygen (DO) sensor

1. Remove the membrane cap mounted on the DO sensor beforehand, and replace it with the new membrane cap provided. Replace the internal solution with fresh solution. The main component of the internal solution is potassium chloride (KCl), so the old solution can be disposed of down a sink or other drain.

Reference

“ 4.6 Replacing the membrane cap ” (page 89)

2. Screw in the DO sensor to attach it, allowing the internal solution to overflow slightly.
3. Use a soft cloth to wipe off the internal solution that overflowed onto the DO sensor.
4. Remove the sensor guard.
5. Remove the sensor plug.
6. Coat the DO sensor O-ring with a thin layer of grease (part No. 3014017718).

Note

Be sure no grease from the O-ring gets on the sensor connector. If the sensor connector gets grease on it, wipe it off with a soft cloth soaked in alcohol.

7. Make sure there is no moisture on the sensor probe's sensor connector (marked "DO").
8. Fasten the DO sensor securely using the spanner for DO sensor.
 - Hold the DO sensor with the provided spanner for DO sensor and push the sensor down. (Step 1 in figure below)
 - Screw the DO sensor in place. (Step 2 in figure below)

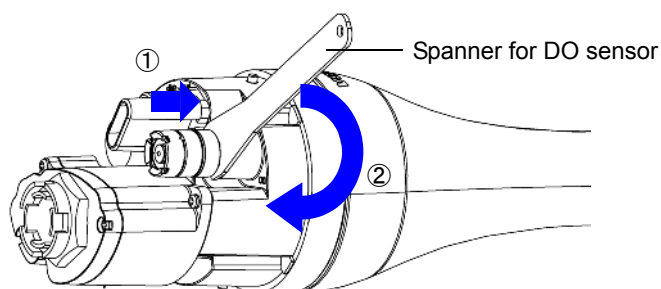

Note

Do not throw away the white cap which has been put on the tip of the sensor. It will be used for the storage.

3.1.4 Connecting the control unit and sensor probe

Note

Connect the control unit with its power OFF.

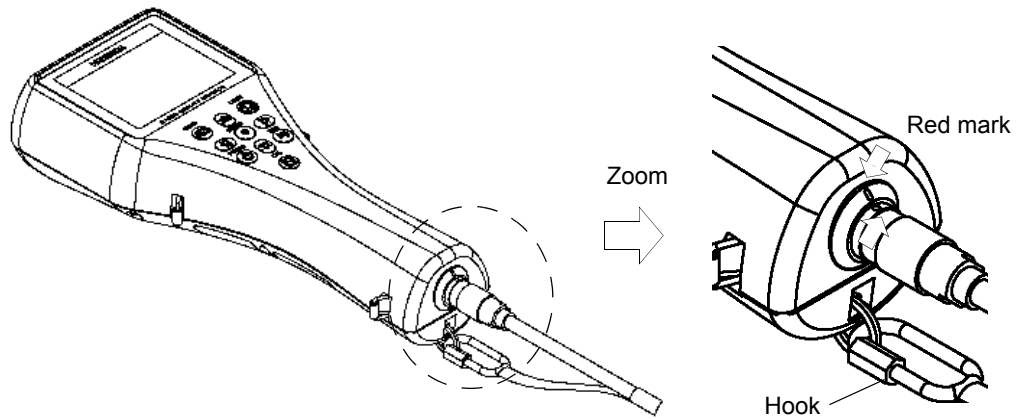

1. Align the red mark on the connector, and press the connector in until you hear it click.
2. Connect the cable's hook to the display.

3.1.5 Conditioning

Carry out the steps below when using the unit for the first time or when the system has not been used for 3 months or longer.

1. **Fill the transparent calibration cup to the line with pH 4 standard solution.**
The transparent calibration cup has With TURB Measurement and Without TURB Measurement gauge lines.
2. **Insert the sensor probe in the transparent calibration cup.**

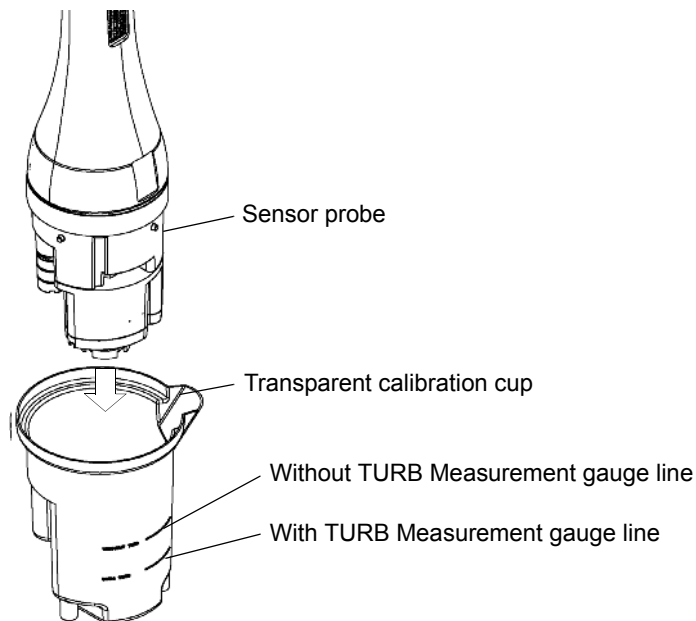

Note

Check that all sensors are attached.

3. Press the control unit's **POWER** key for about 1 second to turn the power ON. Leave the unit for at least 30 minutes to condition the sensors.

Note

The operation keys are designed to operate using the pad of a finger, sharp objects can tear the control unit cover damaging the operation keys.

Tip

- The procedure for immersing the sensor probe in the pH standard solution is the same as that described in " 3.3.1 Auto calibration " (page 41).
Auto calibration can be performed using the same pH 4 standard solution that was used in the conditioning procedure.
- Immersing the sensor in the standard solution is generally required for sensor conditioning, but a voltage supply is required for DO sensor conditioning. Turning ON the power of the control unit is necessary during sensor conditioning.
- DO value will be higher than usual for a while after turning power ON.
See " 6.4.2 Conditioning of DO sensor " (page 105).

3.1.6 GPS (U-52G, U-53G, U-54G)

The GPS position measurement precision is proportional to the GPS position measurement time. When the position measurement precision increases, the position measurement time also increases. See " ● GPS locating accuracy" (page 17) for how to set the position measurement precision. See " ● GPS locate" (page 15) below for how to check acquired GPS data.

● GPS locate

1. Press the right (▷) key to switch the display to the "SETTINGS" screen.
2. Press the down (▽) key to move the cursor to "System", then press the ENTER key.
3. Press the down (▽) key to move the cursor to "GPS locate", then press the ENTER key.

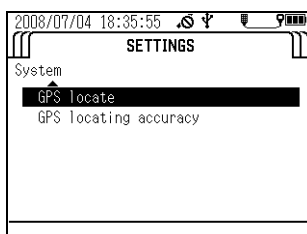

4. The message "Press ENT key to start position measurement." appears. Press the ENTER key.

5. The message "Execute GPS position measurement?" appears. Move the cursor to "YES", then press the ENTER key.

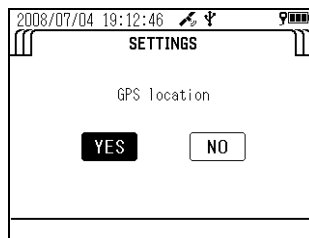

6. The message "Warming up. Please wait." appears. Wait until the system has finished warming up (about 10 seconds).
- Position measurement starts automatically when warmup has finished. Position measurement is performed up to 40 times.
 - The GPS location complete screen appears after successful position measurement.

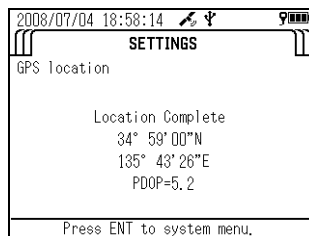

- The GPS location failure screen appears after position measurement has failed. Redo the measurement in a location free from obstacles, or wait for the meteorological conditions to improve before redoing the measurement.

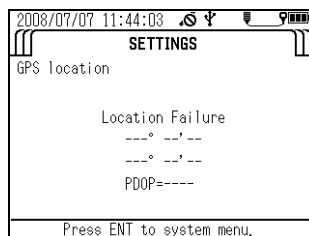

● **GPS locating accuracy**

1. Press the right (▶) key to switch the display to the "SETTINGS" screen.
2. Press the down (▽) key to move the cursor to "System", then press the ENTER key.
3. Press the down (▽) key to move the cursor to "GPS locating accuracy", then press the ENTER key.

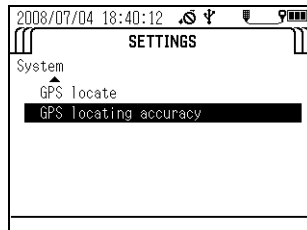

4. The screen below appears. Move the cursor to the locating accuracy, then press the ENTER key. The black circle (●) indicates the currently set precision.

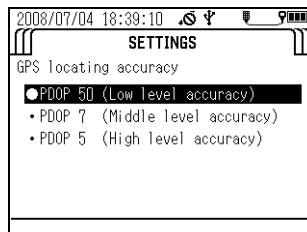

3.2 Settings

3.2.1 Setting measurement methods

This section describes how to set the measurement method.

● Measurement methods

● U-51/U-52/U-54

Single measurement	Pressing the MEAS key acquires the 5-second average for the selected measurement parameter.
Interval measurement	Pressing the MEAS key acquires and saves the 5-second average for the selected measurement parameter in the set interval. The measurement interval can be set to any value between 10 seconds and 24 hours.

● U-53

The U-53 turbidity sensor uses a tungsten lamp. The lamp lights for about 10 seconds, and the average measurement value acquired during this interval is displayed.

Single measurement	Pressing the MEAS key acquires the 5-second average for the selected measurement parameter after wiper operation. The 10-second average is acquired when measuring turbidity.
Interval measurement	Pressing the MEAS key acquires and saves the 5-second average for the selected measurement parameter in the set interval. The 10-second average is acquired when measuring turbidity. The measurement interval can be set to any value between 10 seconds (final check of this value required; 30 seconds may be better for U-52) and 24 hour.

Reference

“ 3.4 Measurement ” (page 63)

● Operation method

1. Press the control unit's POWER key for about 1 second to turn the power ON.

The "MEASUREMENT" screen appears after about 10 seconds.

2008/12/02 14:27:46	
SINGLE MEASUREMENT	
SITE:	
25.23 °C	7.82 mg/L DO
6.99 pH	96.8 % DO
-1 pHmV	0.293 g/L TDS
121 ORPmV	0.1 ppt
0.450 mS/cm	0.0 σt
0.00 NTU	0.00 m
Press MEAS to collect data.	

Note

The operation keys are designed to operate using the pad of a finger, sharp objects can tear the control unit cover damaging the operation keys.

2. Press the right (▷) key to switch the display to the "SETTINGS" screen.

3. Press the down (▽) key to move the cursor to "Measurement", then press the ENTER key.

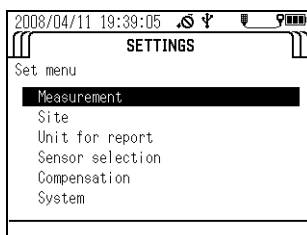

4. Press the down (▽) key to move the cursor to the desired measurement mode. Press the ENTER key to save the setting.

The black circle (●) indicates the currently selected measurement mode.

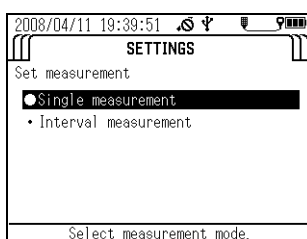

5. If you selected "Interval measurement", the display switches to the screen used to set the measurement interval. Press the up (△) and down (▽) keys to set the measurement interval.

The measurement interval can be set to any value between 10 seconds and 24 hours in the case of the U-51, U-52 and U-54, or between 30 seconds and 24 hours in the case of the U-53.

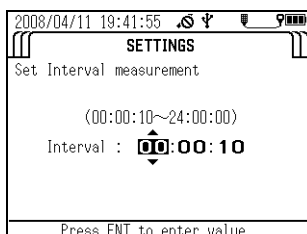

3.2.2 Setting sites

The site function allows position data to be connected to corresponding measurement data. Sites have the following specifications and features:

- Site names: Text data consisting of up to 20 one-byte alphanumeric characters, spaces, etc.
Site names can be used for control unit searches and as labels for computer processing.
- Site names allow measurement data to be saved with a name corresponding to the actual location where it was measured.

You can use site information as a search key when viewing data uploaded by a PC or data saved in the control unit (see "3.5 Data operations" (page 66)).

● Selecting sites

You can select previously created sites. The black circle (●) indicates the name of the currently selected site. No sites are created at new purchasing or after initialization. Select a site after first creating one from the "Create new site" menu.

● Creating new sites

You can create and save new sites. Up to 20 site names can be registered.

● Deleting sites

You can select a previously created site and delete it.

● Operation methods

● Selecting a site

1. Press the control unit's **POWER** key for about 1 second to turn the power ON.

The "MEASUREMENT" screen appears after about 10 seconds.

SINGLE MEASUREMENT	
SITE:	
25.23 °C	7.82 mg/L DO
6.99 pH	96.8 % DO
-1 pHmV	0.293 g/L TDS
121 ORPmV	0.1 ppt
0.450 mS/cm	0.0 σt
0.00 NTU	0.00 m

Press MEAS to collect data.

Note

The operation keys are designed to operate using the pad of a finger, sharp objects can tear the control unit cover damaging the operation keys.

2. Press the right (▷) key to switch the display to the "SETTINGS" screen.
3. Press the down (▽) key to move the cursor to "Site", then press the ENTER key.

SETTINGS
Set menu
Measurement
Site
Unit for report
Sensor selection
Compensation
System

4. Press the down (▽) key to move the cursor to "Select Site", then press the ENTER key to display the names of the currently saved sites.

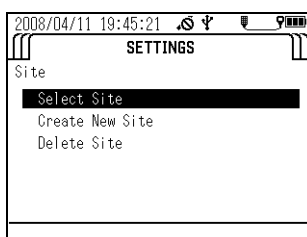

The black circle (●) indicates the currently selected site.

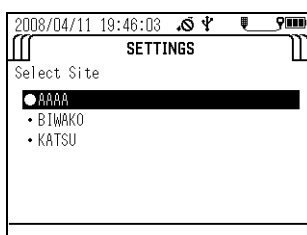

● Creating a new site

1. Press the control unit's **POWER** key for about 1 second to turn the power ON. The "MEASUREMENT" screen appears after about 10 seconds.

The screenshot shows the 'SINGLE MEASUREMENT' screen with the following data:

SITE:	
25.23 °C	7.82 mg/L DO
6.99 pH	96.8 % DO
-1 pHmV	0.293 g/L TDS
121 ORPmV	0.1 ppt
0.450 mS/cm	0.0 σt
0.00 NTU	0.00 m

Press MEAS to collect data.

Note

The operation keys are designed to operate using the pad of a finger, sharp objects can tear the control unit cover damaging the operation keys.

2. Press the right (▷) key to switch the display to the "SETTINGS" screen.
3. Press the down (▽) key to move the cursor to "Site", then press the ENTER key.

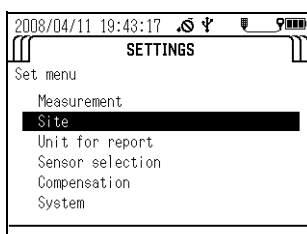

4. Press the down (▽) key to move the cursor to "Create New Site", then press the ENTER key.

Enter the desired site name (up to 20 alphanumeric non-Asian width characters).

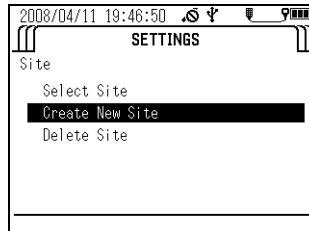

5. Press the up (△), down (▽), right (▷), and left (◁) keys to move the cursor to each letter or number to use in the name, then press the ENTER key to confirm the entered characters. To delete incorrectly entered characters, move the cursor to "BS" and press the ENTER key to start deleting from the last character. When you have finished entering the name, save it by moving the cursor to "SAVE" and pressing the ENTER key.

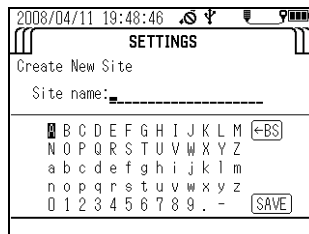

● **Deleting a site**

1. Press the control unit's POWER key for about 1 second to turn the power ON. The "MEASUREMENT" screen appears after about 10 seconds.

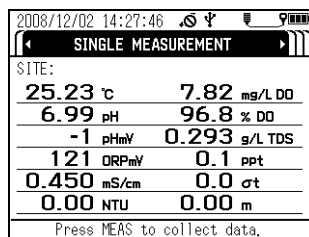

Note

The operation keys are designed to operate using the pad of a finger, sharp objects can tear the control unit cover damaging the operation keys.

2. Press the right (▷) key to switch the display to the "SETTINGS" screen.

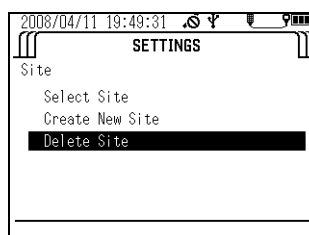

3. Press the down (▽) key to move the cursor to "Site", then press the ENTER key.

4. Press the down (▽) key to move the cursor to "Delete Site", then press the ENTER key.

A list of the currently saved sites appears. The black circle (●) indicates the currently selected site.

SINGLE MEASUREMENT	
SITE:	
25.23 °C	7.82 mg/L DO
6.99 pH	96.8 % DO
-1 pHmV	0.293 g/L TDS
121 ORPmV	0.1 ppt
0.450 mS/cm	0.0 σt
0.00 NTU	0.00 m
Press MEAS to collect data.	

5. Press the down (▽) key to move the cursor to the site to delete, then press the ENTER key to delete it.

The currently selected site can be deleted after a different site has been selected from the site selection menu or after all unselected sites have been deleted. The same site name cannot be registered more than once.

SETTINGS	
Delete Site	
● AAAA	
• BIWAKO	
• KATSU	

3.2.3 Unit for report

Note

Units can only be selected when the sensor probe is connected.

Follow the steps below to set the measurement units of measurement parameters. No units are displayed if a measurement parameter has not been selected in the measurement parameter selection screen (see "3.2.4 Sensor selection" (page 25)).

1. Press the control unit's POWER key for about 1 second to turn the power ON.

The "MEASUREMENT" screen appears after about 10 seconds.

Note

The operation keys are designed to operate using the pad of a finger, sharp objects can tear the control unit cover damaging the operation keys.

2. Press the right (▷) key to switch the display to the "SETTINGS" screen.

3. Press the down (▽) key to move the cursor to "Unit for report", then press the ENTER key.

A list of the currently selected measurement parameters and their units appears. Note that measurement parameters not selected (in the measurement parameter selection screen) are not displayed.

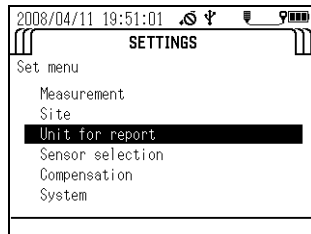

4. Press the up (△) and down (▽) keys to move the cursor to the item to change, then press the ENTER key.

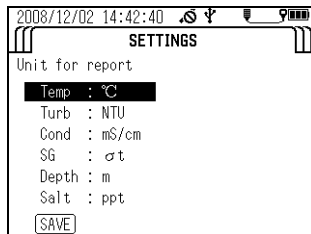

5. A list of the units that can be selected appears. The black circle (●) indicates the currently selected unit. Press the up (△) and down (▽) keys to move the cursor to the desired unit, then press the ENTER key.

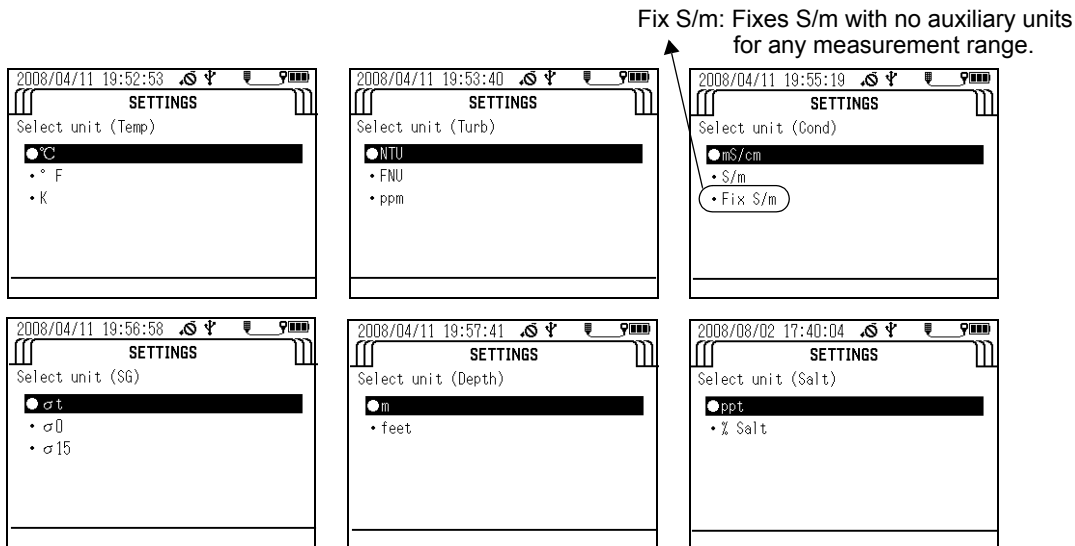

6. To save the changes, press the up (△) and down (▽) keys to move the cursor to SAVE, then press the ENTER key. If you do not want to save the changes, press the ESC key.

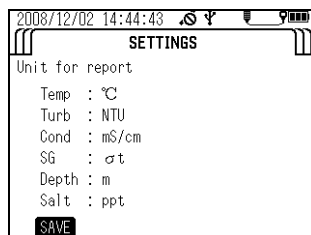

3.2.4 Sensor selection

Note

Measurement parameters can only be selected when the sensor probe is connected.

You can set between 1 and 11 measurement parameters to display in the control unit screen. Follow the steps below to select the desired measurement parameters.

1. Press the control unit's **POWER** key for about 1 second to turn the power ON. The "MEASUREMENT" screen appears after about 10 seconds.

SINGLE MEASUREMENT	
SITE:	
25.23 °C	7.82 mg/L DO
6.99 pH	96.8 % DO
-1 pHmV	0.293 g/L TDS
121 ORPmV	0.1 ppt
0.450 mS/cm	0.0 σt
0.00 NTU	0.00 m

Press MEAS to collect data.

Note

The operation keys are designed to operate using the pad of a finger, sharp objects can tear the control unit cover damaging the operation keys.

2. Press the right (▷) key to switch the display to the "SETTINGS" screen.
3. Press the down (▽) key to move the cursor to "Sensor selection", then press the ENTER key.

A list of the measurement parameters that can be set and the currently set units are displayed.

SETTINGS	
Set menu	
Measurement	
Site	
Unit for report	
Sensor selection	
Compensation	
System	

4. Move the cursor to each measurement parameter to change, then press the ENTER key. A check in the check box of a measurement parameter indicates it will be displayed.
5. To save the changes, press the up (△), down (▽), left (◀) and right (▶) keys to move the cursor to **SAVE**, then press the ENTER key. If you don't want to save the changes, press the ESC key.

Sensor selection	
<input checked="" type="checkbox"/> Temp : °C	<input checked="" type="checkbox"/> DO : mg/L DO
<input checked="" type="checkbox"/> pH : pH	<input checked="" type="checkbox"/> DO% : % DO
<input checked="" type="checkbox"/> pHmV : pHmV	<input checked="" type="checkbox"/> TDS : g/L TDS
<input checked="" type="checkbox"/> ORP : ORPmV	<input checked="" type="checkbox"/> Salt : ppt
<input checked="" type="checkbox"/> Cond : mS/cm	<input checked="" type="checkbox"/> SG : σt
<input checked="" type="checkbox"/> Turb : NTU	<input checked="" type="checkbox"/> Depth: m

[SAVE]

Note

Available measurement parameters differ according to product specifications.

3.2.5 Compensation

Note

Compensation settings can only be made when the sensor probe is connected.

U-50 series have following functions of compensation.

- Salinity compensation and atmospheric pressure compensation for dissolved oxygen (DO)
- Temperature compensation for conductivity (COND)
- Setting total dissolved solid (TDS) coefficient for TDS

● Salinity compensation (DO)

The dissolved oxygen (DO) value is presented higher than actual value if salinity compensation is not added, because the increase of salinity gives higher DO value. To obtain correct value salinity compensation is needed. The following modes are available for calculation of salinity compensation.

AUTO: Salinity compensation is performed automatically with salinity converted from conductivity.

Value input: Press the up (Δ) and down (∇) keys to enter a setting value when the salinity is known.

1. Press the control unit's POWER key for about 1 second to turn the power ON.

The "MEASUREMENT" screen appears after about 10 seconds.

SINGLE MEASUREMENT	
SITE:	
25.23 °C	7.82 mg/L DO
6.99 pH	96.8 % DO
-1 pHmV	0.293 g/L TDS
121 ORPmV	0.1 ppt
0.450 mS/cm	0.0 σt
0.00 NTU	0.00 m

Press MEAS to collect data.

Note

The operation keys are designed to operate using the pad of a finger, sharp objects can tear the control unit cover damaging the operation keys.

2. Press the right (\triangleright) key to switch the display to the "SETTINGS" screen.

3. Press the down (∇) key to move the cursor to "Compensation", then press the ENTER key.

SETTINGS	
Set menu	
Measurement	
Site	
Unit for report	
Sensor selection	
Compensation	
System	

4. Press the down (∇) key to move the cursor to "DO Salinity", then press the ENTER key to toggle the setting between "Auto" and "Input mode".

Default: Auto

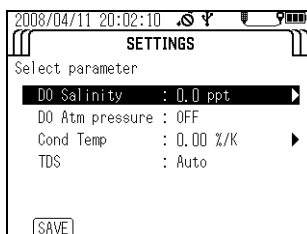

5. If you selected "Input mode", press the right (\triangleright) key to display the compensation value input screen. Press the up (Δ) and down (∇) keys to enter the desired value, then press the ENTER key to set it.

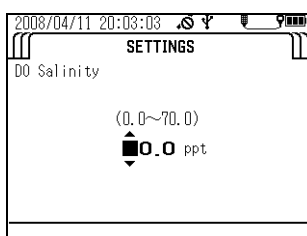

6. To save the change, press the up (Δ) and down (∇) keys to move the cursor to SAVE, then press the ENTER key. If you don't want to save the change, press the ESC key.

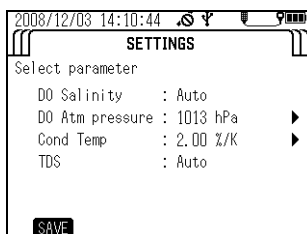

● **Atmospheric pressure compensation (DO)**

Differences in the atmospheric pressure of the measurement location influence the Dissolved Oxygen (DO) measurement. By setting (input) the actual atmospheric pressure of the measurement location into the control unit, it is possible to standardize the measured Dissolved Oxygen (DO) value to a value at the standard atmospheric pressure (1013 hPa).

Reference

“ 6.4.4 Atmospheric pressure compensation (DO) - Relation of altitude and air pressure ” (page 107)

Note

- If air bubble in the internal solution is large, change the internal solution.
- Calibrate at the place of same atmospheric pressure before the measurement.

1. Press the control unit's **POWER** key for about 1 second to turn the power ON.
The "MEASUREMENT" screen appears after about 10 seconds.

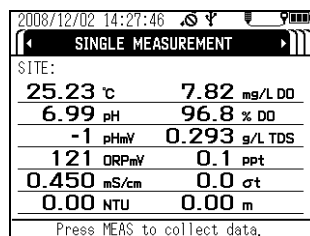

Note

The operation keys are designed to operate using the pad of a finger, sharp objects can tear the control unit cover damaging the operation keys.

2. Press the right (▷) key to switch the display to the "SETTINGS" screen.
3. Press the down (▽) key to move the cursor to "Compensation", then press the ENTER key.

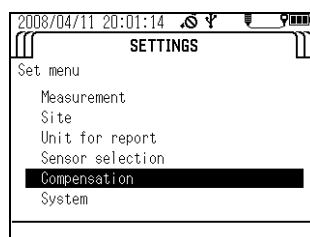

4. Press the down (▽) key to move the cursor to "Cond Temp", then press the ENTER key to toggle the setting between "OFF" and "Input mode".
Default: OFF

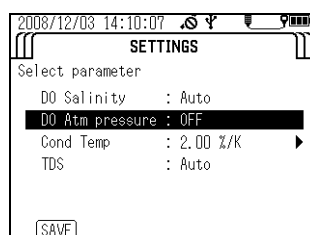

5. If you selected "Input mode", press the right (▷) key to display the compensation value input screen. Press the up (△) and down (▽) keys to enter the desired value, then press the ENTER key to set it.

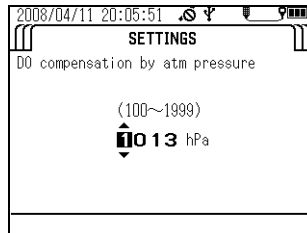

6. To save the change, press the up (△) and down (▽) keys to move the cursor to SAVE, then press the ENTER key. If you don't want to save the change, press the ESC key.

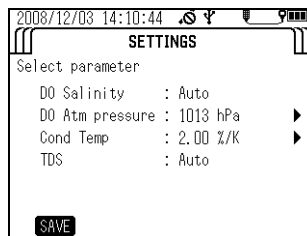

● **Temperature compensation for conductivity (COND)**

Sample conductivity (COND) varies with temperature, and this control unit uses a temperature compensation coefficient to automatically standardize the conductivity (COND) at 25°C. The initial setting coefficient is 2%/K, which is the generally used.

1. Press the control unit's **POWER** key for about 1 second to turn the power ON.

The "MEASUREMENT" screen appears after about 10 seconds.

2008/12/02 14:27:46	
SINGLE MEASUREMENT	
SITE:	
25.23 °C	7.82 mg/L DO
6.99 pH	96.8 % DO
-1 pHmV	0.293 g/L TDS
121 ORPmV	0.1 ppt
0.450 mS/cm	0.0 σt
0.00 NTU	0.00 m
Press MEAS to collect data.	

Note

The operation keys are designed to operate using the pad of a finger, sharp objects can tear the control unit cover damaging the operation keys.

2. Press the right (▷) key to switch the display to the "SETTINGS" screen.
3. Press the down (▽) key to move the cursor to "Compensation", then press the ENTER key.

2008/04/11 20:01:14	
SETTINGS	
Set menu	
Measurement	
Site	
Unit for report	
Sensor selection	
Compensation	
System	

4. Press the down (▽) key to move the cursor to "Cond Temp", then press the ENTER key to toggle the setting between "OFF" and "Input mode".

Default: 2.00%/K

2008/12/03 14:10:07	
SETTINGS	
Select parameter	
DO Salinity	: Auto
DO Atm pressure	: OFF
Cond Temp	: 2.00 %/K ▶
TDS	: Auto
[SAVE]	

5. If you selected "Input mode", press the right (▶) key to display the compensation value input screen. Press the up (▲) and down (▼) keys to enter the desired value, then press the ENTER key to set it.

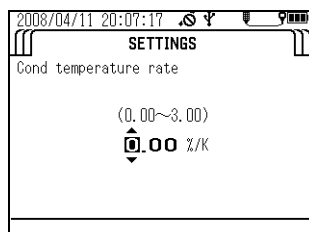

6. To save the change, press the up (▲) and down (▼) keys to move the cursor to **SAVE**, then press the ENTER key.
If you don't want to save the change, press the ESC key.

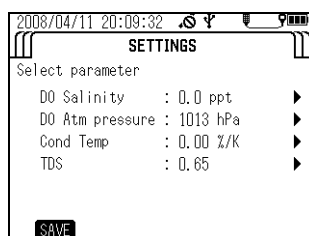

● **Setting a total dissolved solid (TDS) coefficient**

The total dissolved solid amount (TDS) is a converted value obtained by multiplying the conductivity (COND) by a known coefficient.

Three kinds of mode, "AUTO", "EN27888" and "Input mode", can be selected.

● **AUTO**

TDS is calculated according to the coefficient initially set.

The coefficient initially set for the control unit is based on a conversion for KCl and CaCO₃ solutions and it depends on the conductivity (COND) value as shown below.

Conductivity (COND) (S/m)	Conversion coefficient
< 0.05	0.65
0.05 to 0.5	0.64
0.5 to 1	0.63
1 to 3	0.62
3 to 5	0.61
> 5	0.60

● **EN27888**

TDS is calculated according to the European standard "EN27888+DIN38404 (mix of most common ions in natural water)".

Note

This mode is not applicable to the conventional control unit and sensor probe. To confirm the version, see "● Version" (page 35).

	Control unit	Sensor probe
Not applicable version	P2000266001D P2000266001C P2000266001B P2000266001A P2000266001-	P2000267001C P2000267001B P2000267001A P2000267001-

● **Input mode**

TDS is calculated according to the entered coefficient.

1. Press the control unit's **POWER** key for about 1 second to turn the power ON. The "MEASUREMENT" screen appears after about 10 seconds.

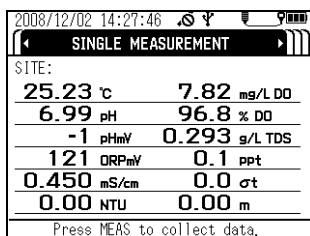

Note

The operation keys are designed to operate using the pad of a finger, sharp objects can tear the control unit cover damaging the operation keys.

2. Press the right (▷) key to switch the display to the "SETTINGS" screen.

3. Press the down (∇) key to move the cursor to "Compensation", then press the ENTER key.

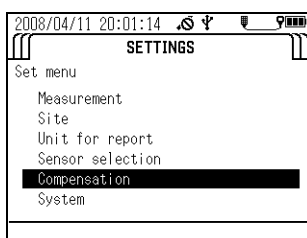

4. Press the down (∇) key to move the cursor to "TDS", then press the ENTER key to switch the setting, "AUTO", "EN27888" and "Input mode".

Default: Auto

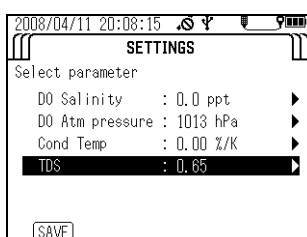

5. If you selected "Input mode", press the right (\triangleright) key to display the compensation value input screen. Press the up (Δ) and down (∇) keys to enter the desired value, then press the ENTER key to set it.

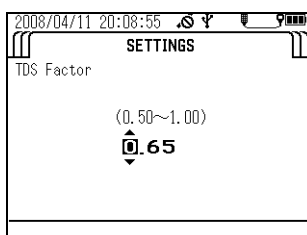

6. To save the change, press the up (Δ) and down (∇) keys to move the cursor to SAVE, then press the ENTER key. If you don't want to save the change, press the ESC key.

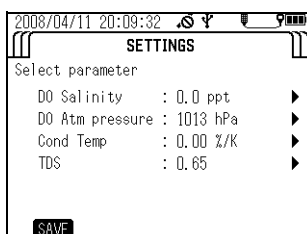

3.2.6 System settings

The system settings let you change the display language, check the system software version, set the date/time, set the auto power OFF time, set the display contrast, and initialize the settings.

● Display language

Follow the steps below to select either English or Japanese as the display language.

1. Press the control unit's **POWER** key for about 1 second to turn the power ON.
The "MEASUREMENT" screen appears after about 10 seconds.

SINGLE MEASUREMENT	
SITE:	
25.23 °C	7.82 mg/L DO
6.99 pH	96.8 % DO
-1 pHmV	0.293 g/L TDS
121 ORPmV	0.1 ppt
0.450 mS/cm	0.0 σt
0.00 NTU	0.00 m
Press MEAS to collect data.	

Note

The operation keys are designed to operate using the pad of a finger, sharp objects can tear the control unit cover damaging the operation keys.

2. Press the right (▷) key to switch the display to the "SETTINGS" screen.
3. Press the down (▽) key to move the cursor to "System", then press the ENTER key.

SETTINGS
Set menu
Measurement
Site
Unit for report
Sensor selection
Compensation
System

4. Press the down (▽) key to move the cursor to "Language", then press the ENTER key.

SETTINGS
System
Language
Version
Date/Time
Auto power off
Display contrast
Initialize

5. A list of the supported display languages appears. Press the up (Δ) and down (∇) keys to move the cursor to the desired language, then press the ENTER key.

The black circle (●) indicates the currently selected display language.

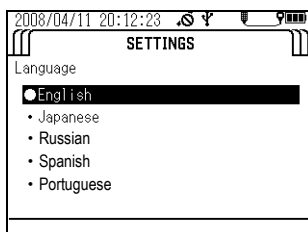

● Version

Follow the steps below to display the program No. and version of the control unit and sensor probe software.

The program No. and version of the sensor probe software will not be displayed if the sensor probe is not connected.

1. Press the control unit's POWER key for about 1 second to turn the power ON.

The "MEASUREMENT" screen appears after about 10 seconds.

2008/12/02 14:27:46

SINGLE MEASUREMENT

SITE:

25.23 °C	7.82 mg/L DO
6.99 pH	96.8 % DO
-1 pHmV	0.293 g/L TDS
121 ORPmV	0.1 ppt
0.450 mS/cm	0.0 σt
0.00 NTU	0.00 m

Press MEAS to collect data.

Note

The operation keys are designed to operate using the pad of a finger, sharp objects can tear the control unit cover damaging the operation keys.

2. Press the right (\triangleright) key to switch the display to the "SETTINGS" screen.
3. Press the down (∇) key to move the cursor to "System", then press the ENTER key.

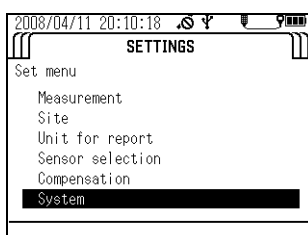

4. Press the down (▽) key to move the cursor to "Version", then press the ENTER key.
The program No. of the control unit and sensor probe software appears.

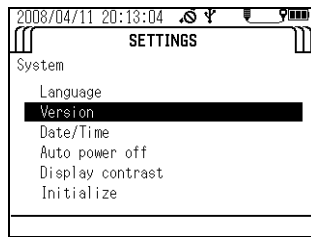

● **Setting the date/time**

Follow the steps below to set the date and time.

1. Press the control unit's POWER key for about 1 second to turn the power ON.
The "MEASUREMENT" screen appears after about 10 seconds.

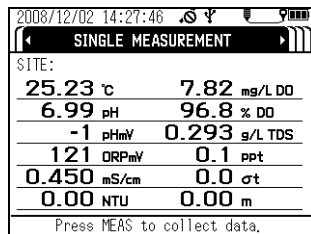

Note

The operation keys are designed to operate using the pad of a finger, sharp objects can tear the control unit cover damaging the operation keys.

2. Press the right (▷) key to switch the display to the "SETTINGS" screen.
3. Press the down (▽) key to move the cursor to "System", then press the ENTER key.

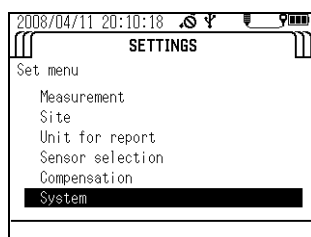

4. Press the down (▽) key to move the cursor to "Date/time", then press the ENTER key.

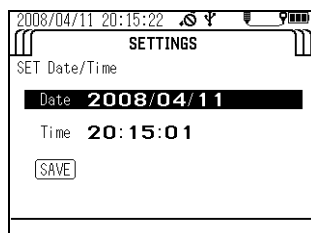

5. Move the cursor to the date, then press the ENTER key.
6. Press the right (▷) key to move the cursor to the year, month, day, hour, minute and second, and press the up (△) and down (▽) keys to enter each value.

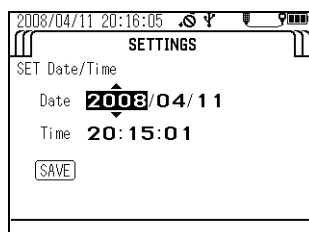

7. When finished entering settings, press the ENTER key to move the cursor to SAVE, then press the ENTER key again to save the settings.

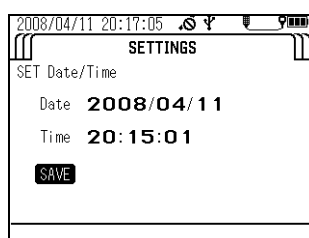

● Setting the auto power OFF time

Follow the steps below to set the time for the auto power OFF function (which turns the power OFF automatically when no operation is performed for the preset amount of time).

1. Press the control unit's POWER key for about 1 second to turn the power ON.

The "MEASUREMENT" screen appears after about 10 seconds.

SINGLE MEASUREMENT	
SITE:	
25.23 °C	7.82 mg/L DO
6.99 pH	96.8 % DO
-1 pHmV	0.293 g/L TDS
121 ORPmV	0.1 ppt
0.450 mS/cm	0.0 σt
0.00 NTU	0.00 m

Press MEAS to collect data.

Note

The operation keys are designed to operate using the pad of a finger, sharp objects can tear the control unit cover damaging the operation keys.

2. Press the right (▷) key to switch the display to the "SETTINGS" screen.
3. Press the down (▽) key to move the cursor to "System", then press the ENTER key.

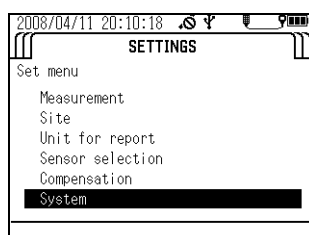

4. Press the down (▽) key to move the cursor to "Auto power off", then press the ENTER key.

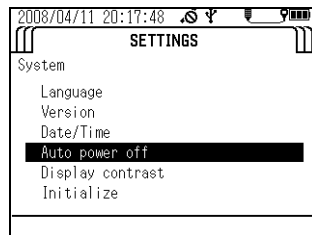

5. Press the up (Δ) and down (∇) keys to select the desired time setting, then press the ENTER key.

You can select OFF, or settings of 1, 2, 5, 10, 20, 30 or 60 minutes.

Default: 30 minutes

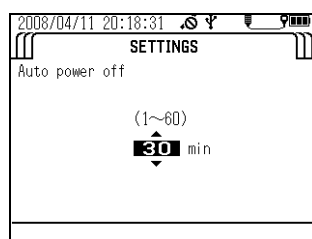

● Display contrast

Follow the steps below to adjust the display's contrast.

1. Press the control unit's POWER key for about 1 second to turn the power ON.

The "MEASUREMENT" screen appears after about 10 seconds.

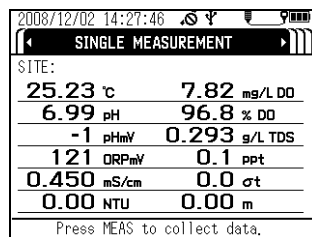

Note

The operation keys are designed to operate using the pad of a finger, sharp objects can tear the control unit cover damaging the operation keys.

2. Press the right (\triangleright) key to switch the display to the "SETTINGS" screen.
3. Press the down (∇) key to move the cursor to "System", then press the ENTER key.

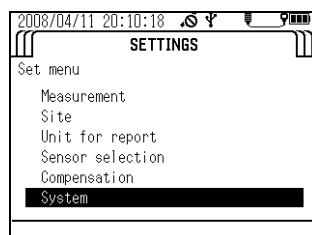

4. Press the down (∇) key to move the cursor to "Display contrast", then press the ENTER key.

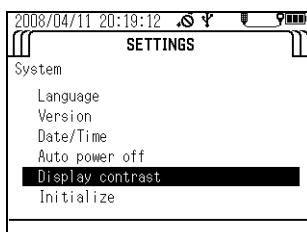

5. Press the left (◀) and right (▶) keys to adjust the contrast.
Adjustment can be made in 26 steps.

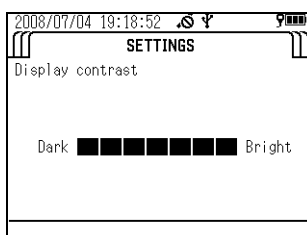

6. Press the ENTER key.

● Initialization

Follow the steps below to restore all the settings except date/time to their factory defaults. Factory default calibration data for the electrical conductivity and turbidity sensors will also be deleted at the same time.

1. Press the control unit's POWER key for about 1 second to turn the power ON.
The "MEASUREMENT" screen appears after about 10 seconds.

SINGLE MEASUREMENT	
SITE:	
25.23 °C	7.82 mg/L DO
6.99 pH	96.8 % DO
-1 pHmV	0.293 g/L TDS
121 ORPmV	0.1 ppt
0.450 mS/cm	0.0 σt
0.00 NTU	0.00 m

Press MEAS to collect data.

Note

The operation keys are designed to operate using the pad of a finger, sharp objects can tear the control unit cover damaging the operation keys.

2. Press the right (▶) key to switch the display to the "SETTINGS" screen.
3. Press the down (▽) key to move the cursor to "System", then press the ENTER key.

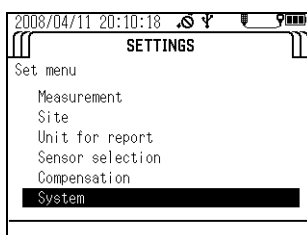

4. Press the down (▽) key to move the cursor to "Initialize", then press the ENTER key.

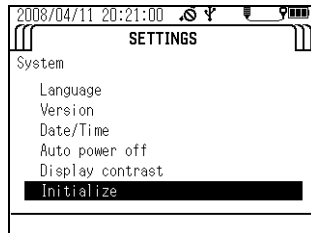

5. Press the ENTER key again.

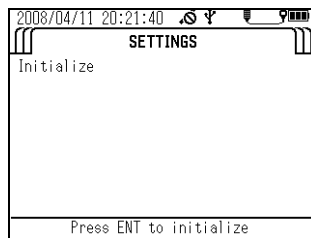

6. A confirmation message appears asking whether to execute initialization. Press the left (◀) key to move the cursor to YES, then press the ENTER key.
The message "Initialize Complete" appears to indicate the process has finished.

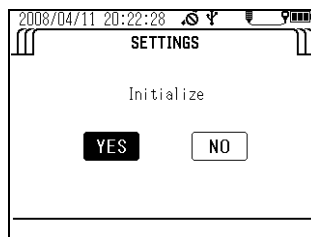

3.3 Calibration

To obtain correct measurement values, the sensors need to be calibrated using standard solution before measurement. You can select simultaneous auto calibration of the pH, COND and TURB sensors in pH4 standard solution and DO and DEP sensors simultaneously in air, or manual calibration of individual measurement parameters. You can check the result of the previous calibration using the procedure on “ 3.5.4 Checking the calibration record ” (page 72).

Note

- Wait at least 30 minutes after turning the system power ON before calibrating the DO sensor.
- Make the DO and COND compensation settings before calibration since these settings are applied during calibration.
- You can select only the desired parameters for calibration and calibrate just those parameters (see “ 3.2.4 Sensor selection ” (page 25)).
- Use about 200 mL of standard solution in the calibration cup.
- Calibration data is stored in the sensor probe.

3.3.1 Auto calibration

Tip

- The following parameters are calibrated (at 25°C):
 pH: Set to 4.01 (zero-point calibration); the span is adjusted to the factory default value.
 COND: 0.449 S/m (4.49 mS/cm, span calibration); the zero point is adjusted to the factory default value.
 TURB: 0 NTU (zero-point calibration); the span is adjusted to the factory default value.
 DO: 8.92 mg/L (span calibration); the zero point is adjusted to the factory default value.
 DEP: 0 m (zero-point calibration); the zero point is adjusted to the factory default value.
- If the air temperature changes, the readout value may not be stable. Ensure that the ambient air temperature is the same temperature as the calibration solution, because the internal probe temperature sensor and external temperature sensor (in the calibration solution) are used for the auto calibration. Allow the probe and standard solution to equilibrate for 1 hour if a thermometer is not available to verify that these temperatures are the same.
- Do not hold the probe while performing the auto calibration. Body temperature may elevate the internal temperature sensor measurement creating DO calibration error.

1. Remove the sensor guard and wash the sensor probe 2 or 3 times with deionized water.

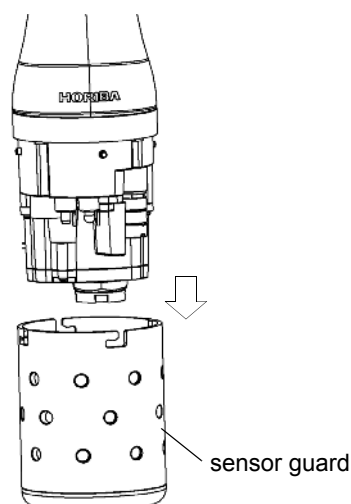

2. Remove the transparent calibration cup.
3. Fill the transparent calibration cup to the line with pH 4 standard solution.
The transparent calibration cup has With TURB Measurement and Without TURB Measurement gauge lines.

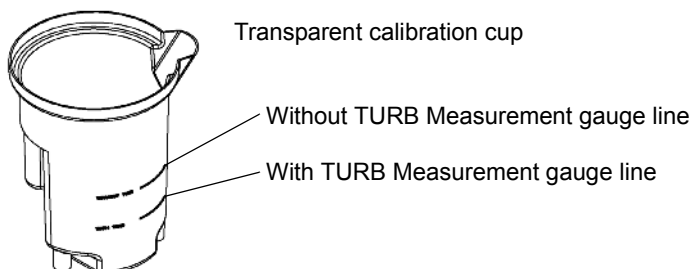

4. Press the control unit's CAL key to set the calibration mode.

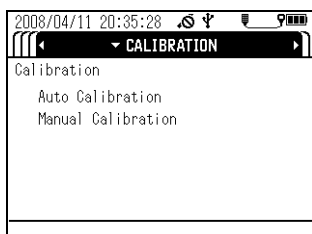

5. Press the down (▽) key to move the cursor to "Auto Calibration", then press the ENTER key.

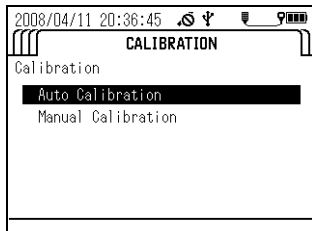

6. Immerse the sensor probe in the transparent calibration cup. Check that the pH sensor, ORP sensor, reference electrode, COND sensor, TURB sensor and temperature sensor are submerged in the pH 4 standard solution and check that there are no air bubbles on the sensor.

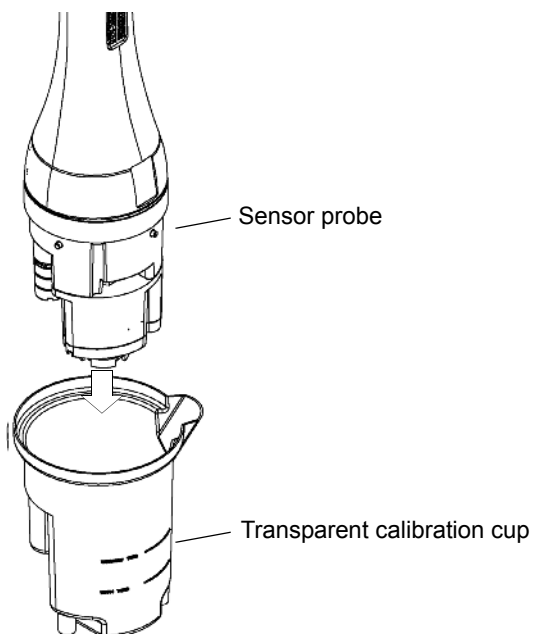
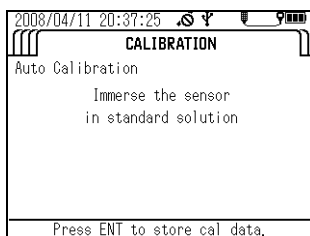

7. With the sensor probe still in the transparent calibration cup, place the transparent calibration cup into the black calibration cup.

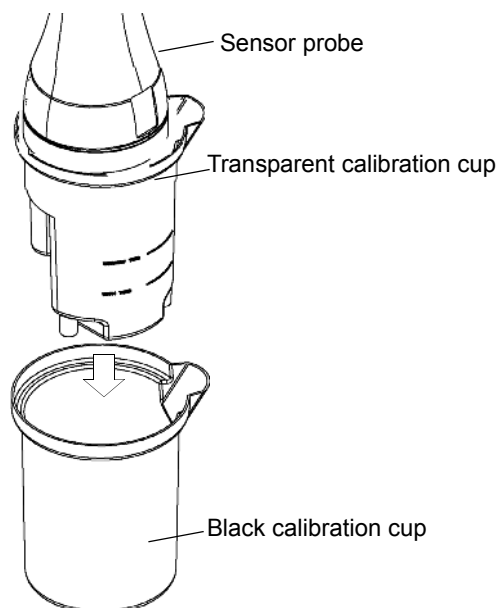

8. Wait for 3 minutes or more until all the sensor values have stabilized, and then press the ENTER key to start calibration.

Note

Do not remove the sensor probe from the calibration solution. U-53 turbidity data will display "----" until the calibration is completed.

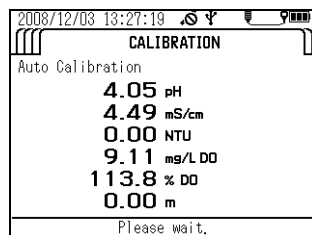

Calibration is finished when the message "Cal complete. MEAS to measure." appears. Press the MEAS key to set the measurement screen, then start measurement.

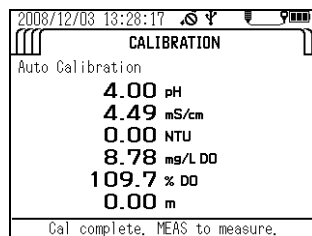

If a calibration error occurs, start calibration after first resolving the issue according to the instructions in "4.7 Troubleshooting" (page 91).

3.3.2 Manual calibration

The procedures below describe how to calibrate each sensor individually.

Note

The displayed units are the units set by selecting "Unit for report" in the "SETTINGS" screen.

● **Temperature (TEMP) calibration**

1. Fill a bucket or similar container with water of a known temperature, and insert the sensor probe in it.
Wait 5 minutes before starting calibration to allow the sensor probe temperature to stabilize.
2. Press the control unit's CAL key to set the calibration mode.
3. Press the down (▽) key to move the cursor to "Manual Calibration", then press the ENTER key.

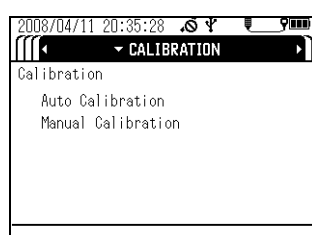

- In the parameter selection screen, move the cursor to "Temp", then press the ENTER key.

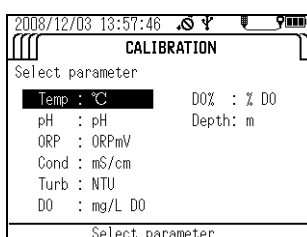

- Press the up (Δ) and down (∇) keys to set the calibration value - the temperature of the water containing the submerged sensor probe.

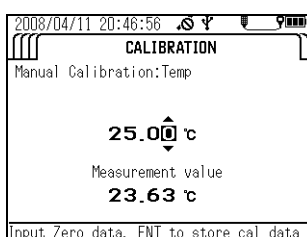

- Check that "Measurement value" has stabilized, then press the ENTER key to start calibration.
Calibration is finished when the message "Cal complete. CNT to measure." appears.

● pH calibration

Note

You can select one calibration point (zero-point calibration) or two calibration points (zero-point calibration and span calibration). Carry out two calibration procedures to ensure good measurement precision throughout all measurement ranges.

- Calibrate the zero point. Wash the transparent calibration cup 2 or 3 times with deionized water, then fill it to the reference line with pH 6.86 standard solution.
- Wash the sensor probe 2 or 3 times in deionized water to remove any dirt, then submerge the sensor probe in the transparent calibration cup.
- Press the control unit's CAL key to set the calibration mode.

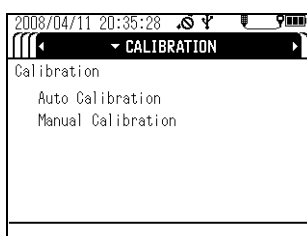

- Press the down (∇) key to move the cursor to "Manual Calibration", then press the ENTER key.

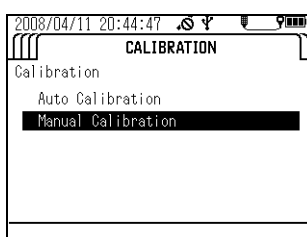

5. In the parameter selection screen, move the cursor to "pH", then press the ENTER key.

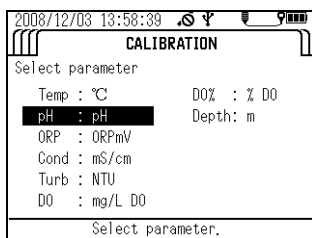

6. Set the number of calibration points, then press the ENTER key.

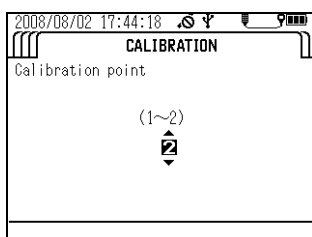

7. Press the up (Δ) and down (▽) keys to set the pH value of the pH 6.86 standard solution containing the submerged sensor probe at the measurement temperature

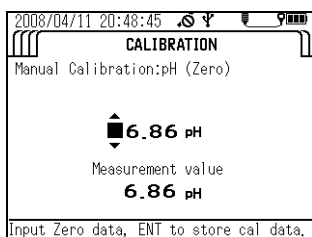

Table 1 Indicated value of HORIBA pH standard solutions at various temperatures (pH)

Temp. (°C)	pH 4 standard solution Phthalate	pH 6.86 standard solution Neutral phosphate	pH 9 standard solution Borate
0	4.01	6.98	9.46
5	4.01	6.95	9.39
10	4.00	6.92	9.33
15	4.00	6.90	9.27
20	4.00	6.88	9.22
25	4.01	6.86	9.18
30	4.01	6.85	9.14
35	4.02	6.84	9.10
40	4.03	6.84	9.07
45	4.04	6.84	9.04

Table 2 Indicated value of other pH standard solutions at various temperatures (pH)

Temp. (°C)	pH 7 standard solution Neutral phosphate	pH 10 standard solution Carbonate
0	7.12	10.32
5	7.09	10.25
10	7.06	10.18
15	7.04	10.12
20	7.02	10.06
25	7.00	10.01
30	6.99	9.97
35	6.98	9.93
40	6.97	9.89
45	6.97	9.86

8. Check that "Measurement value" has stabilized, then press the ENTER key to start calibration.
9. Press the ENTER key to start the span calibration procedure when the message "Cal complete. Press ENT to Span cal." appears.

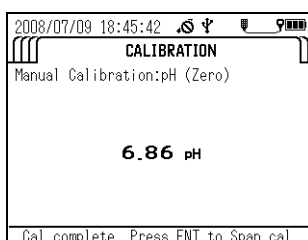

10. Wash the transparent calibration cup 2 or 3 times with deionized water, then fill it to the reference line with pH 4 or pH 9 standard solution.
11. Wash the sensor probe 2 or 3 times in deionized water to remove any dirt, then submerge the sensor probe in the transparent calibration cup.
12. Press the up (Δ) and down (∇) keys to set the pH value of the pH 4 or pH 9 standard solution containing the submerged sensor probe at the measurement temperature.

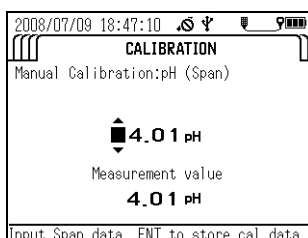

13. Check that "Measurement value" has stabilized, then press the ENTER key to start calibration.

14. Calibration is finished when the message "Cal complete. ENT to manual cal menu." appears. Press the ENTER key to return to the calibration parameter

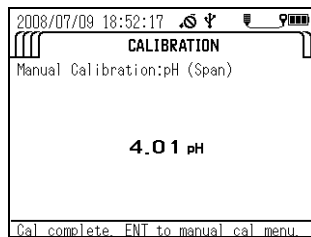

● **ORP calibration**

Note

- If the prepared ORP standard solution is left in open air for one hour or more, the solution may be transformed. For this reason ORP standard solution cannot be stored. Calibrate within one hour of preparing the solution.
- When measuring sample with low concentrations of oxidants and reductants after conducting an operational check using a standard substance, the measured values may not stabilize or the results of measurement might not be repeatable. If this is the case, start the measurement after immersing the sensors in the sample water sufficiently.
- Note that when measuring the ORP of solution with extremely low concentrations of oxidants and reductants, such as tap water, well water, or water treated with purifying equipment, there may be less responsiveness, repeatability, and stability, in general.
- When alkaline ion water is left for 5 minutes, its ORP undergoes changes significantly. Always measure alkaline ion water promptly.

1. Fill a clean beaker with one bag of ORP standard powder No. 160-22 or No. 160-51. Add 250 mL of deionized water and agitate the solution thoroughly (there will be some excess quinhydrone (a black powder) that floats on the surface when agitating the solution). Fill the transparent calibration cup to the reference line with this standard solution.
2. Wash the sensor probe 2 or 3 times in deionized water to remove any dirt, then submerge the sensor probe in the transparent calibration cup.
3. Press the control unit's CAL key to set the calibration mode.
4. Press the down (▽) key to move the cursor to "Manual Calibration", then press the ENTER key.

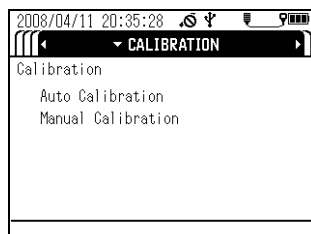

5. In the parameter selection screen, move the cursor to ORP, then press the ENTER key.

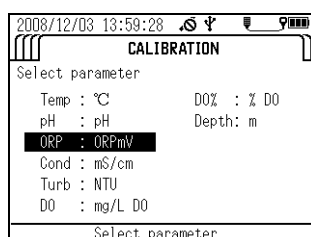

6. Press the up (Δ) and down (∇) keys to set the mV value of the ORP standard solution containing the submerged sensor probe at the measurement temperature.

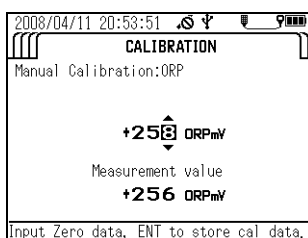

Table 3 Indicated value of ORP standard solution at various temperatures (mV)

Temperature	160-22	16051
5	+274	+112
10	+271	+107
15	+267	+101
20	+263	+95
25	+258	+89
30	+254	+83
35	+249	+76
40	+244	+69

7. Check that "Measurement value" has stabilized, then press the ENTER key to start calibration.
8. Calibration is finished when the message "Cal complete. ENT to manual cal menu." appears. Press the ENTER key to return to the calibration parameter selection screen.

● **Conductivity (COND) calibration**

Note

- To support a wide range of sample concentrations, electrical conductivity is divided into three measurement ranges: 0.0 mS/m to 99.9 mS/m, 0.090 S/m to 0.999 S/m, and 0.9 S/m to 9.99 S/m.
- When manually calibrating conductivity, you can select two calibration points (one zero-point calibration point and a span calibration point for one of the three measurement ranges) or four calibration points (one zero-point calibration point and span calibration points for all three measurement ranges). Carry out the four calibration points to ensure good measurement precision throughout all measurement ranges.
- Make the compensation setting before calibration since this setting is applied during calibration. (Refer to “ 6.5.3 Temperature coefficient ” (page 111)).

1. Prepare the standard solution. Dry Potassium chloride (KCl) powder (high-grade commercially available) at 105°C for two hours, and leave it to cool in a desiccator.
2. Consult the following table and weigh potassium chloride (KCl), then prepare three standard potassium chloride (KCl) solutions following the procedure below.

Potassium chloride (KCl) standard solution	Conductivity (COND) value	Potassium chloride (KCl) mass (g) at solution temperature of 25°C	Calibration range
0.005 mol/L	71.8 mS/m (0.718 mS/cm)	0.373	0.0 mS/m to 99.9 mS/m (0.00 mS/cm to 0.999 mS/cm)
0.050 mol/L	0.667 S/m (6.67 mS/cm)	3.73	0.090 S/m to 0.999 S/m (1.00 mS/cm to 9.99 mS/cm)
0.500 mol/L	5.87 S/m (58.7 mS/cm)	37.2	0.9 S/m to 9.99 S/m (10.0 mS/cm to 99.9 mS/cm)

3. Dissolve the weighed Potassium Chloride (KCl) in deionized water.
4. Put the dissolved Potassium Chloride (KCl) into a 1 L measuring flask, and fill to the 1 L mark with deionized water.
5. Calibrate the zero point. Wash the sensor probe 2 or 3 times in deionized water to remove any dirt, then remove all moisture from the sensor probe (it will be calibrated in air).
6. Press the control unit's CAL key to set the calibration mode.
7. Press the down (▽) key to move the cursor to "Manual Calibration", then press the ENTER key.

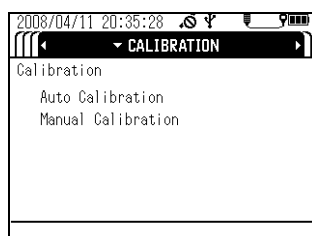

8. In the parameter selection screen, move the cursor to "Cond", then press the ENTER key.

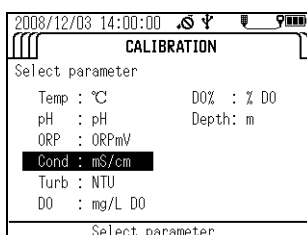

9. Set the number of calibration points, then press the ENTER key.

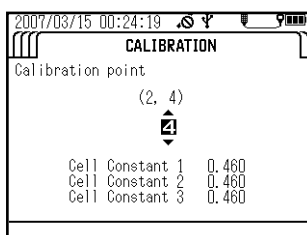

The instructions below assume that four calibration points have been set.

10. Press the up (Δ) and down (∇) keys to set the "Cond" value to 0.0 mS/m (0.000 mS/cm).
11. Check that "Measurement value" has stabilized, then press the ENTER key to start calibration.

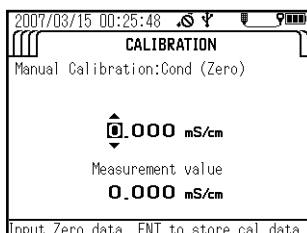

12. When the message "Cal complete. Press ENT to Span cal." appears, press the ENTER key to start the first span calibration procedure.

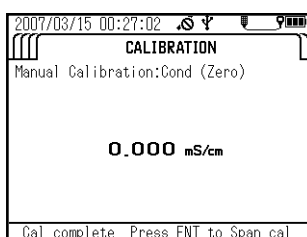

13. Wash the transparent calibration cup 2 or 3 times with deionized water, then fill it to the reference line with 71.8 mS/m (0.718 mS/cm) standard solution.
14. Wash the sensor probe 2 or 3 times in deionized water to remove any dirt, then submerge the sensor probe in the transparent calibration cup.

15. Press the up (Δ) and down (∇) keys to set the "Cond" value to 71.8 mS/m (0.718 mS/cm).

Calibration range = 0 mS/m to 99.9 mS/m (0 mS/cm to 0.999 mS/cm)

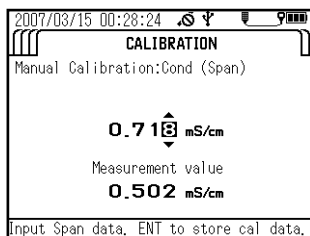

16. Check that "Measurement value" has stabilized, then press the ENTER key to start calibration.
17. When the message "Cal complete. Press ENT to Span cal." appears, press the ENTER key to start the next span calibration procedure.

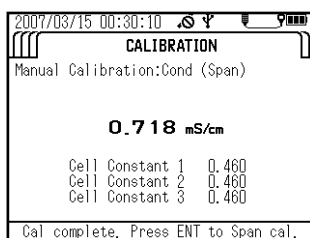

18. Wash the transparent calibration cup 2 or 3 times with deionized water, then fill it to the reference line with 0.667 S/m (6.67 mS/cm) standard solution.
19. Wash the sensor probe 2 or 3 times in deionized water to remove any dirt, then submerge the sensor probe in the transparent calibration cup.
20. Press the up (Δ) and down (∇) keys to set the "Cond" value to 0.667 S/m (6.67 mS/cm).

Calibration range = 0.100 S/m to 0.999 S/m (1.00 mS/cm to 9.99 mS/cm)

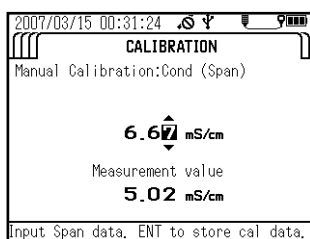

21. Check that "Measurement value" has stabilized, then press the ENTER key to start calibration.
22. When the message "Cal complete. Press ENT to Span cal." appears, press the ENTER key to start the next span calibration procedure.

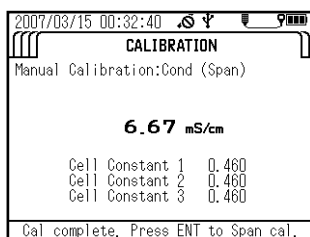

23. Wash the transparent calibration cup 2 or 3 times with deionized water, then fill it to the reference line with 5.87 S/m (58.7 mS/cm) standard solution.
24. Wash the sensor probe 2 or 3 times in deionized water to remove any dirt, then submerge the sensor probe in the transparent calibration cup.
25. Press the up (Δ) and down (∇) keys to set the "Cond" value to 5.87 S/m (58.7 mS/cm).
Calibration range = 1.00 S/m to 10.00 S/m(10.0 mS/cm to 100.0 mS/cm)

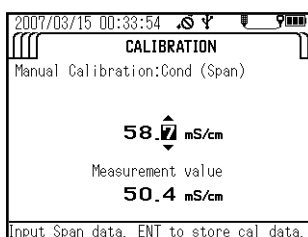

26. Check that "Measurement value" has stabilized, then press the ENTER key to start calibration.
27. Calibration is finished when the message "Cal complete. ENT to manual cal menu." appears. Press the ENTER key to return to the calibration parameter selection screen.

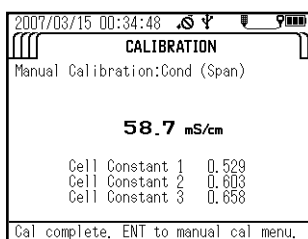

● Turbidity (TURB) calibration

Note

- To support a wide range of sample concentrations, turbidity is divided into three measurement ranges: 0.0 to 9.9 NTU, 10 to 100 NTU, and over 100 NTU.
- When manually calibrating turbidity, you can select two calibration procedures (one zero-point calibration procedure and a span calibration procedure for one of the three measurement ranges), three calibration procedures (one zero-point calibration procedure and a span calibration procedure for two of the three measurement ranges) or four calibration procedures (one zero-point calibration procedure and span calibration procedures for all three measurement ranges). Carry out the four calibration procedures to ensure good measurement precision throughout all measurement ranges.
- Always use the calibration cup provided. Using other containers can create effects from ambient light that cause incorrect calibration.

● Preparing the standard solutions

1. Weigh out 5.0 g of hydrazine sulfate (commercial special grade or above), and dissolve it in 400 mL of deionized water. Dissolve 50 g of hexamethylene tetramine (commercial special grade or above) in 400 mL of deionized water in another flask.
2. Mix the two solutions and add deionized water until the total solution volume is 1000 mL, and mix well. Store this solution at a temperature of 25°C ±3°C for 48 hours.

The turbidity value (TURB) of this solution is equivalent to 4000 NTU.

3. Dilute 4000 NTU-solution 5 times (use a pipette to measure 50 mL of the 4000 NTU solution and pour it into a 250 mL measuring flask, and fill up to 250 mL meniscus)
The turbidity value (TURB) of this solution is equivalent to 800 NTU.
4. Dilute 800 NTU solution 10 times (use a pipette to measure 25 mL of the 800 NTU solution and pour it into a 250 mL measuring flask, and fill up to 250 mL meniscus)
The turbidity value (TURB) of this solution is equivalent to 80 NTU.
5. Dilute 80 NTU solution 10 times (use a pipette to measure 25 mL of the 80 NTU solution and pour it into a 250 mL measuring flask, and fill up to 250 mL meniscus)
The turbidity value (TURB) of this solution is equivalent to 8 NTU.

Note

Instead of the standard solutions above, you can use other standard solutions of known concentration measured with other standard instruments.

● U-52, U-53, U-54 turbidity calibration

Set the number of calibration points.

You can set between 2 and 4 points.

1. Press the control unit's CAL key to set the calibration mode.
2. Press the down (▽) key to move the cursor to "Manual Calibration", then press the ENTER key.

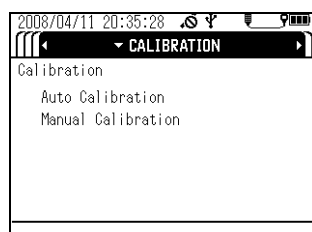

3. In the parameter selection screen, move the cursor to "Turb", then press the ENTER key.

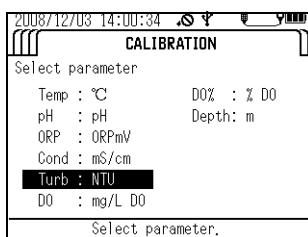

4. Press the up (△) and down (▽) keys to set the number of calibration points, then press the ENTER key.

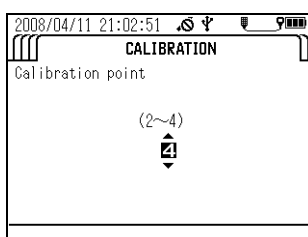

The instructions below assume that four calibration points have been set.

5. Calibrate the zero point. Wash the transparent calibration cup 2 or 3 times with deionized water, then fill it to the reference line with deionized water.
6. Wash the sensor probe 2 or 3 times in deionized water to remove any dirt, then submerge the sensor probe in the transparent calibration cup.
7. Press the up (△) and down (▽) keys to set the "Turb" value to 0.0 NTU.

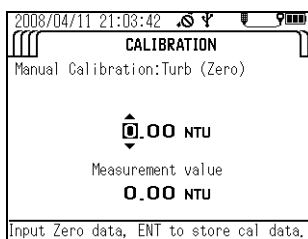

8. Check that "Measurement value" has stabilized, then press the ENTER key to start calibration.

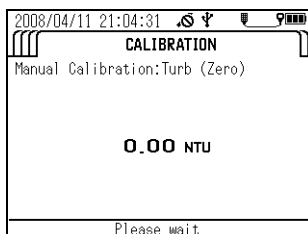

9. When the message "Cal complete. Press ENT to Span cal." appears, press the ENTER key to start the first span calibration procedure.

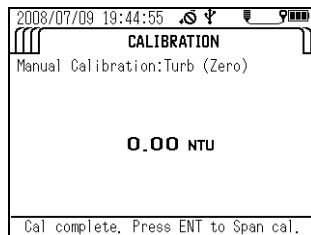

10. Wash the transparent calibration cup 2 or 3 times with deionized water, then fill it to the reference line with 8 NTU standard solution, or a standard solution of known concentration between 0.1 and 10 NTU.
11. Wash the sensor probe 2 or 3 times in deionized water to remove any dirt, then submerge the sensor probe in the transparent calibration cup.
12. Press the up (Δ) and down (∇) keys to set the "TURB" value to 8 NTU, or to the known concentration of the standard solution between 0.1 and 10 NTU. (Input range = 0 NTU to 9.9 NTU (U-52, U-54) or 0 NTU to 9.99 NTU (U-53))

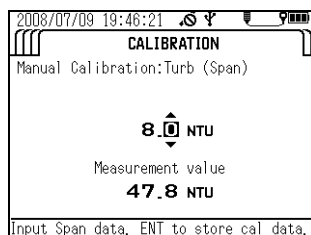

13. Check that "Current measurement value" has stabilized, then press the ENTER key to start calibration.
14. When the message "Cal complete. Press ENT to Span cal." appears, press the ENTER key to start the next span calibration procedure.

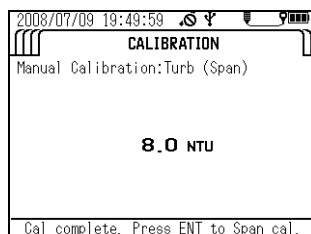

15. Wash the transparent calibration cup 2 or 3 times with deionized water, then fill it to the reference line with 80 NTU standard solution, or a standard solution of known concentration between 10 and 100 NTU.
16. Wash the sensor probe 2 or 3 times in deionized water to remove any dirt, then submerge the sensor probe in the transparent calibration cup.

17. Press the up (Δ) and down (∇) keys to set the "Turb" value to 80 NTU, or to the known concentration of the standard solution between 10 and 100 NTU. (Input range = 10.0 NTU to 99.9 NTU)

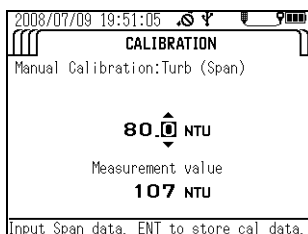

18. Check that "Measurement value" has stabilized, then press the ENTER key to start calibration.
19. When the message "Cal complete. Press ENT to Span cal." appears, press the ENTER key to start the next span calibration procedure.

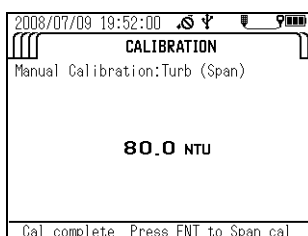

20. Wash the transparent calibration cup 2 or 3 times with deionized water, then fill it to the reference line with 800 NTU standard solution, or a standard solution of known concentration 100 NTU above.
21. Wash the sensor probe 2 or 3 times in deionized water to remove any dirt, then submerge the sensor probe in the transparent calibration cup.
22. Press the up (Δ) and down (∇) keys to set the "TURB" value to 800 NTU, or to the known concentration of the standard solution 100 NTU above. (Input range = 100 NTU to 800 NTU (U-52), 100 NTU to 1000 NTU (U-53, U-54))

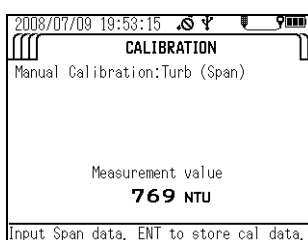

23. Check that "Measurement value" has stabilized, then press the ENTER key to start calibration.
24. Calibration is finished when the message "Cal complete. ENT to manual cal menu." appears. Press the ENTER key to return to the calibration parameter selection screen.

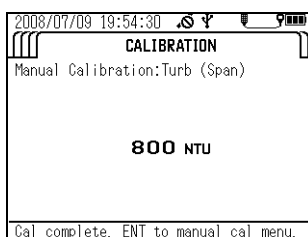

● Dissolved oxygen (DO) calibration

Note

- You can select one calibration procedure (span calibration) or two calibration procedures (zero-point calibration and span calibration). Carry out the two calibration procedures to ensure good measurement precision throughout all measurement ranges.
- It is necessary to prepare new solution before calibration of the Dissolved Oxygen (DO) sensor.
- The calibration cup (included) cannot be used to manually calibrate the DO sensor. Use a suitable bottle in which the DO sensor and the temperature sensor can be immersed.
- Wait at least 20 minutes after turning the system power ON before calibrating the DO sensor.
- Make the compensation setting before calibration since the setting is applied during calibration.
- The DO sensor is affected by flow. When performing span calibration with saturated dissolved oxygen water, move the cable slowly up and down (move the sensor probe at a rate of roughly 20 to 30 cm a second) or agitate the saturated dissolved oxygen water.

1. Prepare the standard solution.

- Add about 50 g of sodium sulfite to 1000 mL of water (either deionized water or tap water) and stir the mixture to dissolve the sodium sulfite in it.
- Pour 1 to 2 liters of water into a suitable flask (either deionized water or tap water). Using an air pump, feed air into the water and aerate the solution until oxygen is saturated.

2. First, calibrate the zero point. Press the control unit's CAL key to set the calibration mode.

3. Press the down (▽) key to move the cursor to "Manual Calibration", then press the ENTER key.

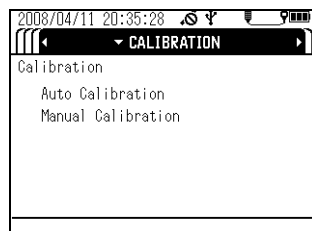

4. In the parameter selection screen, move the cursor to DO or DO%, then press the ENTER key.

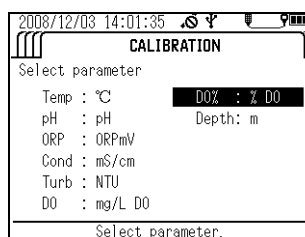
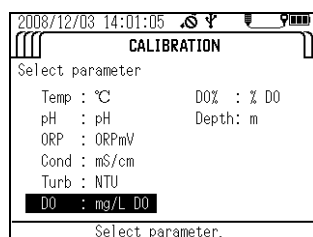

5. Set the number of calibration procedures, then press the ENTER key.

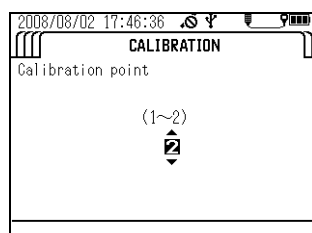

The instructions below assume that two calibration points have been set.

6. Wash the sensor probe 2 or 3 times in deionized water to remove any dirt, then submerge the sensor probe in the bottle.
7. Press the up (Δ) and down (∇) keys to set the DO value to 0.00 mg/L or 0.0%.

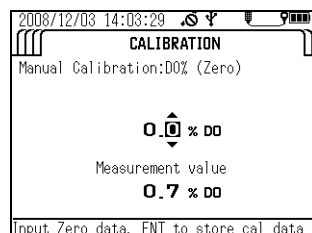
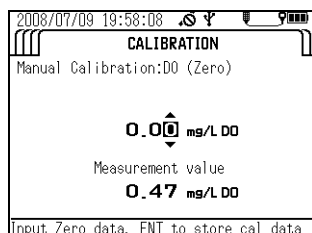

8. Check that "Measurement value" has stabilized, then press the ENTER key to start calibration.
9. When the message "Cal complete. Press ENT to Span cal." appears, press the ENTER key to start the span calibration procedure.

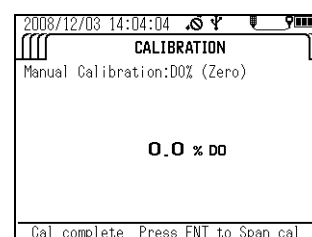
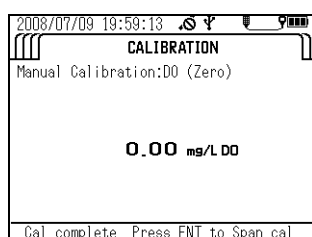

10. Wash the sensor probe 2 or 3 times with deionized water to remove any dirt, then submerge the sensor probe in the container filled with the span solution.
11. Press the up (Δ) and down (∇) keys to set the DO value to the saturated dissolved oxygen value (mg/L) of the water at that temperature or the dissolved oxygen saturation ratio.

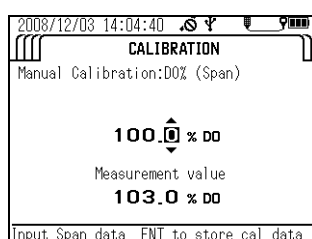
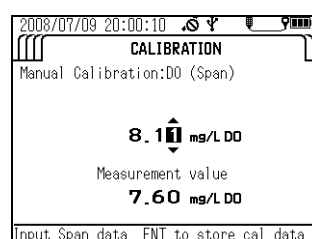

12. Check that "Measurement value" has stabilized, then press the ENTER key to start calibration.
13. Calibration is finished when the message "Cal complete. ENT to manual cal menu." appears. Press the ENTER key to return to the calibration parameter selection screen.

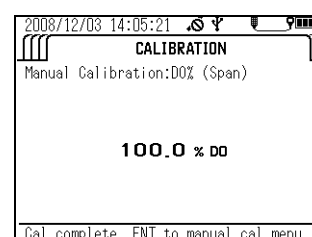
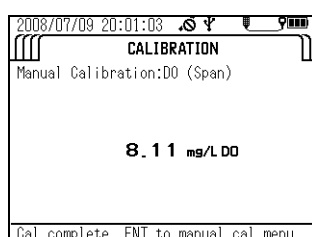

**Amounts of saturated dissolved oxygen in water at various temperatures
(salinity=0.0%)**

JIS K0101

Temp. (°C)	DO (mg/L)	Temp. (°C)	DO (mg/L)	Temp. (°C)	DO (mg/L)	Temp. (°C)	DO (mg/L)
0	14.16						
1	13.77	11	10.67	21	8.68	31	7.42
2	13.40	12	10.43	22	8.53	32	7.32
3	13.04	13	10.20	23	8.39	33	7.22
4	12.70	14	9.97	24	8.25	34	7.13
5	12.37	15	9.76	25	8.11	35	7.04
6	12.06	16	9.56	26	7.99	36	6.94
7	11.75	17	9.37	27	7.87	37	6.86
8	11.47	18	9.18	28	7.75	38	6.76
9	11.19	19	9.01	29	7.64	39	6.68
10	10.92	20	8.84	30	7.53	40	6.59

ISO5814

Temp. (°C)	DO (mg/L)	Temp. (°C)	DO (mg/L)	Temp. (°C)	DO (mg/L)
0	14.62				
1	14.22	11	11.03	21	8.91
2	13.83	12	10.78	22	8.74
3	13.46	13	10.54	23	8.58
4	13.11	14	10.31	24	8.42
5	12.77	15	10.08	25	8.26
6	12.45	16	9.87	26	8.11
7	12.14	17	9.66	27	7.97
8	11.84	18	9.47	28	7.83
9	11.56	19	9.28	29	7.69
10	11.29	20	9.09	30	7.56

● Span setting values for calibration in air

The software should display these values when auto calibration is performed.

Use this table to input values for manual span calibrations in air.

— Tip —

The DO measurement value of “air-saturated water” and air are different.

Due to the pressure difference against the membrane in air versus the membrane in water, the measurement value in air is about 10% higher than the value of air-saturated water on average.

Amounts of saturated dissolved oxygen in air at various temperatures

Following tables are applicable only to the air calibration of the U-50 DO sensor. Do not use them for other purpose.

Air calibration value converted from amounts of saturated dissolved oxygen in water at various temperatures (salinity = 0.0%) JIS K0101

Temp (°C)	DO (mg/L)	Temp (°C)	DO (mg/L)	Temp (°C)	DO (mg/L)	Temp (°C)	DO (mg/L)
0	15.58						
1	15.15	11	11.74	21	9.55	31	8.16
2	14.74	12	11.47	22	9.38	32	8.05
3	14.34	13	11.22	23	9.23	33	7.94
4	13.97	14	10.97	24	9.08	34	7.84
5	13.61	15	10.74	25	8.92	35	7.74
6	13.27	16	10.52	26	8.79	36	7.63
7	12.93	17	10.31	27	8.66	37	7.55
8	12.62	18	10.10	28	8.53	38	7.44
9	12.31	19	9.91	29	8.40	39	7.35
10	12.01	20	9.72	30	8.28	40	7.25

Air calibration value converted from amounts of saturated dissolved oxygen in water at various temperatures (salinity = 0.0%) ISO5814

Temp. (°C)	DO (mg/L)	Temp. (°C)	DO (mg/L)	Temp. (°C)	DO (mg/L)
0	16.08				
1	15.64	11	12.13	21	9.80
2	15.21	12	11.86	22	9.61
3	14.81	13	11.59	23	9.44
4	14.42	14	11.34	24	9.26
5	14.05	15	11.09	25	9.09
6	13.70	16	10.86	26	8.92
7	13.35	17	10.63	27	8.77
8	13.02	18	10.42	28	8.61
9	12.72	19	10.21	29	8.46
10	12.42	20	10.00	30	8.32

● **Water depth (DEPTH) calibration**

1. Calibrate the zero point. Wash the sensor probe 2 or 3 times in deionized water to remove any dirt, then remove all moisture from the sensor probe (it will be calibrated in air).
2. Press the control unit's CAL key to set the calibration mode.
3. Press the down (▽) key to move the cursor to "Manual Calibration", then press the ENTER key.

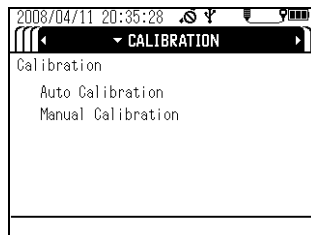

4. In the parameter selection screen, move the cursor to "Depth", then press the ENTER key.

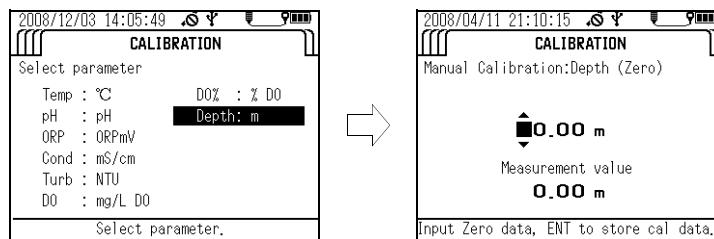

5. Press the up (△) and down (▽) keys to set the "Depth" value to 0.00 m.
6. Check that "Measurement value" has stabilized, then press the ENTER key to start calibration.

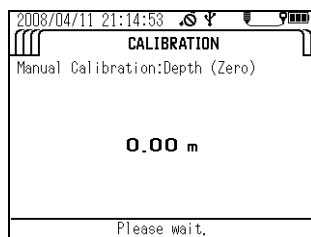

7. Calibration is finished when the message "Cal complete. ENT to manual cal menu." appears. Press the ENTER key to return to the calibration parameter selection screen.

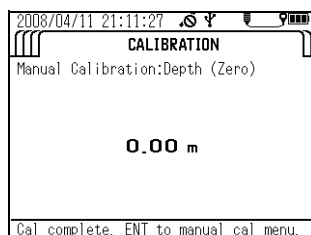

3.4 Measurement

You can perform measurement by either of the methods below.

- Storing data in memory manually with reference to the measurement value (single measurement)
- Having data stored in memory automatically and continuously
 - U-51/U-52/U-54: Interval measurement (minimum memory interval of 10 seconds)
 - U-53: Interval measurement (minimum memory interval of 30 seconds)

Select the measurement method that meets your requirements.

Note

- Lower sensor probe slowly when submerging them in samples.
- Sensors may break if sensor probe are dropped from a height of 1 meter or more.
- Do not submerge sensor probe in water depths of over 30 meters. Sensor probe are only resistant to water pressure of up to 30 meters.
- After turning the power ON, check that the DO readout value has stabilized before starting measurement (takes around 30 minutes).
- If water temperature is different from air temperature by 10°C or more, wait for about 20 minutes after immersing sensor probe into water. (U-54, U-54)

Tip

- When on the measurement screen, pressing the ENTER key enlarges the display and shows three measured values at a time.
- Pressing the up (Δ) and down (∇) keys scrolls through the measured values one item at a time.
- Pressing the ENTER key again reverts to the normal measurement screen display.

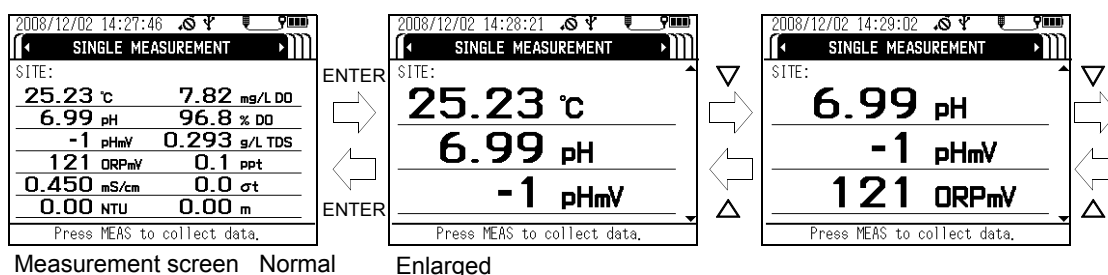

3.4.1 Storing data in memory manually

Follow the steps below to manually store data in memory while referring to the measurement value to check the readout value is stable.

- **U-51/U-52/U-54**
 1. Check that each sensor and sensor guard is mounted.
 2. Check that "SINGLE MEASUREMENT" has been selected in the measurement screen.

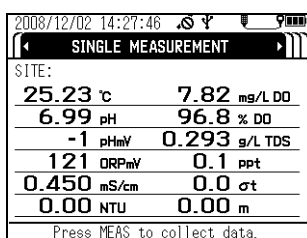

- Submerge the sensor probe in the sample, gently shaking them in the sample to remove any air bubbles from the sensors.

If the sample is non-flowing, move the cable slowly up and down (move the sensor probe at a rate of roughly 20 to 30 cm a second) to ensure that fresh sample is continuously supplied to the DO sensor.

- When the measurement values are stable, press the MEAS key to acquire the 5-second average.

2008/12/02 15:24:22	
SINGLE MEASUREMENT	
SITE:AAAA	
22.71 °C	8.34 mg/L DO
6.42 pH	98.9 % DO
30 pHmV	0.441 g/L TDS
475 ORPmV	0.2 ppt
0.689 mS/cm	0.0 σt
0.00 NTU	0.00 m
Collecting data.	

- Press the ENTER key to save the held measurement values, or press the ESC key to cancel the operation.

2008/12/02 15:25:06	
SINGLE MEASUREMENT	
SITE:AAAA	
22.71 °C	8.36 mg/L DO
6.42 pH	99.1 % DO
30 pHmV	0.441 g/L TDS
475 ORPmV	0.2 ppt
0.689 mS/cm	0.0 σt
0.00 NTU	0.00 m
Press ENT to store data.	



2008/12/02 15:25:45	
SINGLE MEASUREMENT	
SITE:AAAA	
22.71 °C	8.30 mg/L DO
6.42 pH	98.5 % DO
30 pHmV	0.441 g/L TDS
475 ORPmV	0.2 ppt
0.689 mS/cm	0.0 σt
0.00 NTU	0.00 m
Store data complete. Press ESC key.	

U-53

Note

Do not perform turbidity measurement in air as it may damage the wiper.

U-53 turbidity measurement follows the sequence below. The measurement values are held after each sequence.

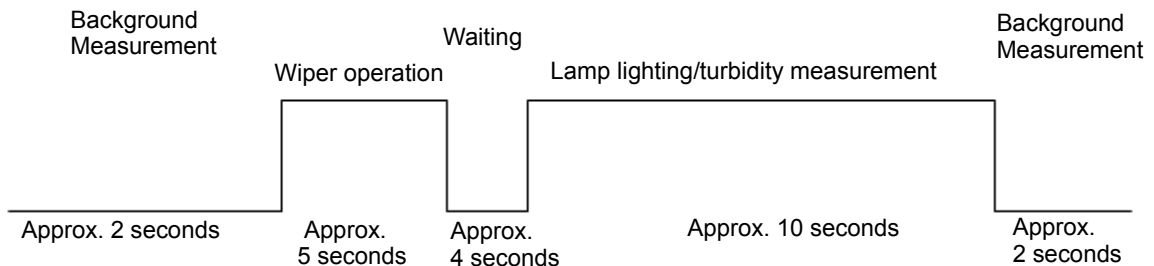

- Check that each sensor and sensor guard is mounted.
- Check that "SINGLE MEASUREMENT" has been selected in the measurement screen.

2008/12/02 14:27:46	
SINGLE MEASUREMENT	
SITE:	
25.23 °C	7.82 mg/L DO
6.99 pH	96.8 % DO
-1 pHmV	0.293 g/L TDS
121 ORPmV	0.1 ppt
0.450 mS/cm	0.0 σt
0.00 NTU	0.00 m
Press MEAS to collect data.	

3. Submerge the sensor probe in the sample, gently shaking them in the sample to remove any air bubbles from the sensors.

If the sample is non-flowing, move the cable slowly up and down (move the sensor probe at a rate of roughly 20 to 30 cm a second) to ensure that fresh sample is continuously supplied to the DO sensor.

4. When the non-turbidity meter measurement values are stable, press the MEAS key to start the sequence above.

2008/12/02 15:24:22		SINGLE MEASUREMENT	
SITE:AAAA			
22.71 °C	8.34 mg/L DO		
6.42 pH	98.9 % DO		
30 pHmV	0.441 g/L TDS		
475 ORPmV	0.2 ppt		
0.689 mS/cm	0.0 σt		
0.00 NTU	0.00 m		
Collecting data.			

5. When the sequence has finished, hold the measurement values. Press the ENTER key to store the held measurement values, or press the ESC key to cancel the operation.

2008/12/02 15:25:06		SINGLE MEASUREMENT	
SITE:AAAA			
22.71 °C	8.36 mg/L DO		
6.42 pH	99.1 % DO		
30 pHmV	0.441 g/L TDS		
475 ORPmV	0.2 ppt		
0.689 mS/cm	0.0 σt		
0.00 NTU	0.00 m		
Press ENT to store data.			

→

2008/12/02 15:25:45		SINGLE MEASUREMENT	
SITE:AAAA			
22.71 °C	8.30 mg/L DO		
6.42 pH	98.5 % DO		
30 pHmV	0.441 g/L TDS		
475 ORPmV	0.2 ppt		
0.689 mS/cm	0.0 σt		
0.00 NTU	0.00 m		
Store data complete. Press ESC key.			

3.4.2 Automatic, continuous measurement

● Interval measurement

1. Select the "Interval measurement" measurement setting (see " 3.2.1 Setting measurement methods " (page 18)).
2. Press the up (Δ) and down (▽) keys to set the interval value to the desired value (U-51/U-52/U-54: minimum interval: 10 seconds, U-53: minimum interval: 30 seconds), then press the ENTER key.

The measurement screen appears automatically, and the system becomes ready for measurement.

3. Check that each sensor and sensor guard is mounted.
4. Submerge the sensor probe in the sample, gently shaking them in the sample to remove any air bubbles from the sensors.

If the sample is non-flowing, move the cable slowly up and down (move the sensor probe at a rate of roughly 20 to 30 cm a second) to ensure that fresh sample is continuously supplied to the DO sensor.

5. Press the ENTER key to start measurement.

2008/12/02 15:28:24		INTERVAL MEASUREMENT	
SITE:HORIBA			
22.76 °C	8.38 mg/L DO		
6.44 pH	99.6 % DO		
28 pHmV	0.442 g/L TDS		
462 ORPmV	0.2 ppt		
0.690 mS/cm	0.0 σt		
0.00 NTU	0.00 m		
Interval measuring. ESC to previous.			

3.5 Data operations

Use the procedures below to retrieve data stored in memory, delete all the data, check the remaining data memory capacity, and check the calibration record.

3.5.1 Displaying data

For maximum efficiency, there are 3 methods of displaying data.

- Displaying the data for a specified site
- Displaying the data for a specified date/time
- Displaying all the data

Use the method that best suits your requirements.

● Displaying the data for a specified site

1. Press the control unit's **POWER** key for about 1 second to turn the power ON.
The "MEASUREMENT" screen appears after about 10 seconds.

SINGLE MEASUREMENT	
SITE:	
25.23 °C	7.82 mg/L DO
6.99 pH	96.8 % DO
-1 pHmV	0.293 g/L TDS
121 ORPmV	0.1 ppt
0.450 mS/cm	0.0 σt
0.00 NTU	0.00 m

Press MEAS to collect data.

Note

The operation keys are designed to operate using the pad of a finger, sharp objects can tear the control unit cover damaging the operation keys.

2. Press the right (▷) key 3 times to display the "DATA OPERATION" screen.
3. Press the down (▽) key to move the cursor to "View Data", then press the ENTER key.

DATA OPERATION	
Data Operation	
View Data	
Delete Data	
Data Memory check	
Calibration record	

4. Move the cursor to "Site", then press the ENTER key.

DATA OPERATION	
View Data	
Site	
Date	
All	

5. Press the up (△), down (▽), left (◀) and right (▷) keys to enter the site to retrieve.

6. Move the cursor to "Search", then press the ENTER key.

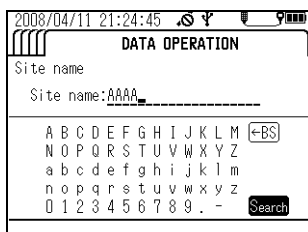

All site names that begin with the entered text are displayed.

The most recently measured data for the entered site is displayed.

7. Press the up (△) and down (▽) keys to display earlier data.

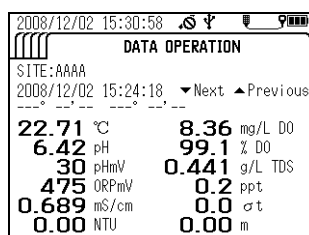

● Displaying the data for a specified date/time

1. Press the control unit's POWER key for about 1 second to turn the power ON.

The "MEASUREMENT" screen appears after about 10 seconds.

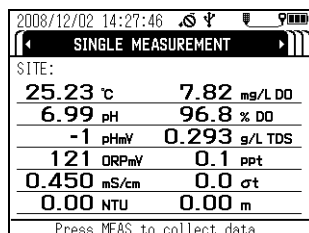

Note

The operation keys are designed to operate using the pad of a finger, sharp objects can tear the control unit cover damaging the operation keys.

2. Press the right (▷) key 3 times to display the "DATA OPERATION" screen.

3. Press the down (▽) key to move the cursor to "View Data", then press the ENTER key.

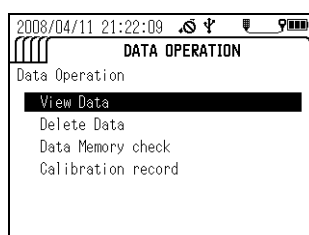

4. Move the cursor to "Date", then press the ENTER key.

5. With the cursor on the Date, press the ENTER key.

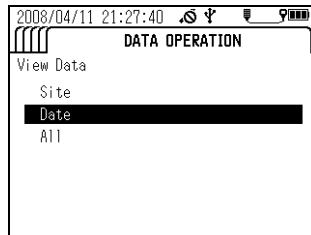

6. Press the up (Δ), down (∇), left (\triangleleft) and right (\triangleright) keys to enter the desired date/time, then press the ENTER key to apply the setting.
7. The cursor moves to "Search". Press the ENTER key to start the search.
8. Press the up (Δ) and down (∇) keys to display earlier data.

● Displaying all the data

1. Press the control unit's POWER key for about 1 second to turn the power ON. The "MEASUREMENT" screen appears after about 10 seconds.

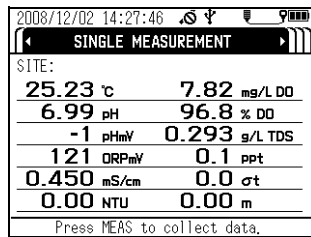

Note

The operation keys are designed to operate using the pad of a finger, sharp objects can tear the control unit cover damaging the operation keys.

2. Press the right (\triangleright) key 3 times to display the "DATA OPERATION" screen.
3. Press the down (∇) key to move the cursor to "View Data", then press the ENTER key.

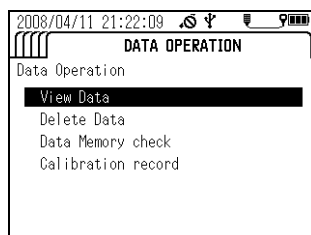

4. Move the cursor to "All", then press the ENTER key.

The most recently measured data is displayed.

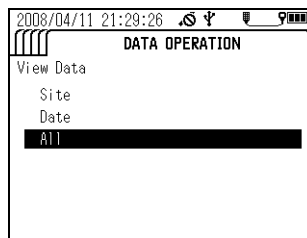
**5. Press the up (△) and down (▽) keys to display earlier data.**

3.5.2 Deleting data

Follow the steps below to delete all the data stored in memory.

1. Press the control unit's **POWER** key for about 1 second to turn the power ON.
The "MEASUREMENT" screen appears after about 10 seconds.

SINGLE MEASUREMENT	
SITE:	
25.23 °C	7.82 mg/L DO
6.99 pH	96.8 % DO
-1 pHmV	0.293 g/L TDS
121 ORPmV	0.1 ppt
0.450 mS/cm	0.0 σt
0.00 NTU	0.00 m

Press MEAS to collect data.

Note

The operation keys are designed to operate using the pad of a finger, sharp objects can tear the control unit cover damaging the operation keys.

2. Press the right (▷) key 3 times to display the "DATA OPERATION" screen.
3. Press the down (▽) key to move the cursor to "Delete Data", then press the ENTER key.

DATA OPERATION	
Data Operation	
View Data	
Delete Data	
Data Memory check	
Calibration record	

4. Press the left (◁) key to move the cursor to YES, then press the ENTER key.
All the data has been deleted when the indicator appears along with the message "No data exists".

DATA OPERATION	
Delete Data	
YES	NO

3.5.3 Checking the data memory

You can check the used data capacity and the remaining data capacity.

1. Press the control unit's **POWER** key for about 1 second to turn the power ON.
The "MEASUREMENT" screen appears after about 10 seconds.

SINGLE MEASUREMENT	
SITE:	
25.23 °C	7.82 mg/L DO
6.99 pH	96.8 % DO
-1 pHmV	0.293 g/L TDS
121 ORPmV	0.1 ppt
0.450 mS/cm	0.0 σt
0.00 NTU	0.00 m
Press MEAS to collect data.	

Note

The operation keys are designed to operate using the pad of a finger, sharp objects can tear the control unit cover damaging the operation keys.

2. Press the right (▷) key 3 times to display the "DATA OPERATION" screen.
3. Press the down (▽) key to move the cursor to "Data Memory Check", then press the ENTER key.

DATA OPERATION	
Data Operation	
View Data	
Delete Data	
Data Memory check	
Calibration record	

The amount of memory in use and amount of available memory are displayed.

DATA OPERATION	
Data Memory check	
Used memory	
0 Data	
Available memory	
10000 Data	

3.5.4 Checking the calibration record

Follow the steps below to check the latest calibration history.

1. Press the control unit's **POWER** key for about 1 second to turn the power ON. The "MEASUREMENT" screen appears after about 10 seconds.

2008/12/02 14:27:46			
SINGLE MEASUREMENT			
SITE:			
25.23 °C	7.82	mg/L DO	
6.99 pH	96.8	% DO	
-1 pHmV	0.293	g/L TDS	
121 ORPmV	0.1	ppt	
0.450 mS/cm	0.0	σt	
0.00 NTU	0.00	m	
Press MEAS to collect data.			

Note

The operation keys are designed to operate using the pad of a finger, sharp objects can tear the control unit cover damaging the operation keys.

2. Press the right (▷) key 3 times to display the "DATA OPERATION" screen.
3. Press the down (▽) key to move the cursor to "Calibration record", then press the ENTER key. The latest calibration record is displayed.



3.5.5 GPS data operations

The menu for GPS data operations appears on the display to which the GPS unit is mounted.

● GPS information

Follow the steps below to display acquired GPS information.

Note

Turning the power OFF erases the GPS information.

1. Press the right (▷) key to switch the display to the "DATA OPERATION" screen.
2. the down (▽) key to move the cursor to "GPS Information", then press the ENTER key.

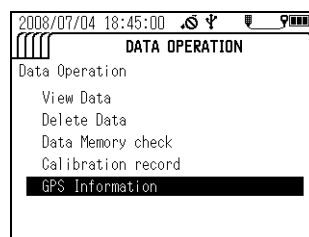

The last GPS information acquired is displayed.

- When received data exists

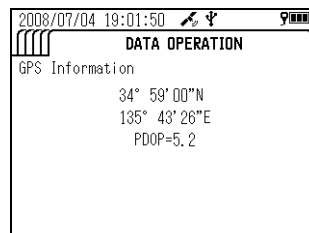

- When no received data exists

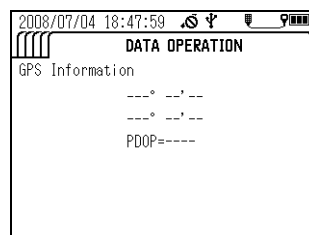

3.6 Sensor information

1. Press the control unit's **POWER** key for about 1 second to turn the power ON.
The "MEASUREMENT" screen appears after about 10 seconds.

Note

The operation keys are designed to operate using the pad of a finger, sharp objects can tear the control unit cover damaging the operation keys.

2. Press the left (<) key once to display the "INFORMATION" screen.

The "Sensor Information" screen displays the sensor probe's status.

- When the sensor probe is normal, the display below appears.

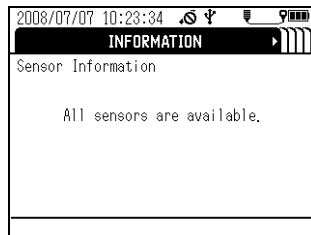

- When there is a sensor probe problem, individual measurement parameters generate messages such as the one shown below. Follow the troubleshooting information to remove the problem before continuing to operate the system.

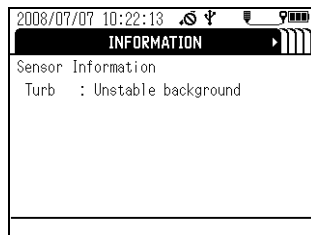

3.7 USB communication

The separately-sold, dedicated PC connection cable comes with data collection software. This software allows data to be downloaded from the control unit in CSV format.

This section contains instructions for communication commands used for USB communication.

● Connecting the cable

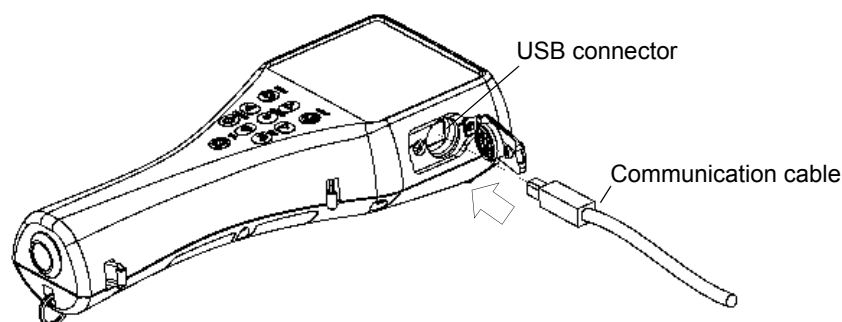

Dedicated cable

Part name: Communication cable (with data collection software)

Part no.: 3200174823

● Cautions when using USB communication

Take care to observe the following when using USB communication.

- Use the dedicated cable (with data collection software) or a commercially-available USB cable (A-B type) to connect to a PC.
- Be sure to match the transmission format on the control unit and the computer.

The control unit uses the following transmission format:

Baud rate:	19200 bps
Number of stop bits:	1 bit
Data bit length:	8 bits
Parity:	None
Flow control:	None

Tip

If the transmission formats do not match, a communication error occurs and USB communication will not function normally. After changing the transmission format, restart the control unit and the computer.

- If received data is not sent back or an error occurs after a data request has been sent, adjust the program configuration so that it allows a little waiting time before a data request is sent again. This will enable more stable communication.
- The unit does not use DCD, CTS, or DSR signals. Take care of this when creating programs.

3.7.1 Communication settings

Baud rate:	19200 bps
Number of stop bits:	1 bit
Data bit length:	8 bits
Parity:	None
Flow control:	None

```

XX  X  X  XXXXX X  XX  X  X  XXXXX X  XX  X  X  XXXXX X
57  58 59 60      61 62  63 64  65      66 67  68 69  70      71

```

```

XX XX XX XX XX XX XX XX XX X  X  XXX XX XX X  X  @  XX [CR] [LF]
72 73 74 75 76 77 78 79 80 81 82 83  84 85 86 87 88 89

```

1	Header		1 character
2	Command		2 characters
3	Site name	Upper- and lowercase letters, numbers, periods (.) hyphens (-) and spaces ()	20 characters
4	Probe status	(3) Status code	1 character
5	Probe error	(4) Status error code	1 character
6	Unused		4 characters
7	Parameter 1 code	(1) Parameter code	2 characters
8	Parameter 1 status	(5) Parameter status code	1 character
9	Parameter 1 error	(6) Parameter error code	1 character
10	Parameter 1 data	5 characters including decimal point, right-justified with blanks filled	5 characters
11	Parameter 1 unit	(2) Unit code	1 character
12	Parameter 2 code	(1) Parameter code	2 characters
13	Parameter 2 status	(5) Parameter status code	1 character
14	Parameter 2 error	(6) Parameter error code	1 character
15	Parameter 2 data	5 characters including decimal point, right-justified with blanks filled	5 characters
16	Parameter 2 unit	(2) Unit code	1 character
17	Parameter 3 code	(1) Parameter code	2 characters
18	Parameter 3 status	(5) Parameter status code	1 character
19	Parameter 3 error	(6) Parameter error code	1 character
20	Parameter 3 data	5 characters including decimal point, right-justified with blanks filled	5 characters
21	Parameter 3 unit	(2) Unit code	1 character
22	Parameter 4 code	(1) Parameter code	2 characters
23	Parameter 4 status	(5) Parameter status code	1 character
24	Parameter 4 error	(6) Parameter error code	1 character
25	Parameter 4 data	5 characters including decimal point, right-justified with blanks filled	5 characters
26	Parameter 4 unit	(2) Unit code	1 character
27	Parameter 5 code	(1) Parameter code	2 characters
28	Parameter 5 status	(5) Parameter status code	1 character
29	Parameter 5 error	(6) Parameter error code	1 character
30	Parameter 5 data	5 characters including decimal point, right-justified with blanks filled	5 characters
31	Parameter 5 unit	(2) Unit code	1 character
32	Parameter 6 code	(1) Parameter code	2 characters
33	Parameter 6 status	(5) Parameter status code	1 character
34	Parameter 6 error	(6) Parameter error code	1 character

35	Parameter 6 data	5 characters including decimal point, right-justified with blanks filled	5 characters
36	Parameter 6 unit	(2) Unit code	1 character
37	Parameter 7 code	(1) Parameter code	2 characters
38	Parameter 7 status	(5) Parameter status code	1 character
39	Parameter 7 error	(6) Parameter error code	1 character
40	Parameter 7 data	5 characters including decimal point, right-justified with blanks filled	5 characters
41	Parameter 7 unit	(2) Unit code	1 character
42	Parameter 8 code	(1) Parameter code	2 characters
43	Parameter 8 status	(5) Parameter status code	1 character
44	Parameter 8 error	(6) Parameter error code	1 character
45	Parameter 8 data	5 characters including decimal point, right-justified with blanks filled	5 characters
46	Parameter 8 unit	(2) Unit code	1 character
47	Parameter 9 code	(1) Parameter code	2 characters
48	Parameter 9 status	(5) Parameter status code	1 character
49	Parameter 9 error	(6) Parameter error code	1 character
50	Parameter 9 data	5 characters including decimal point, right-justified with blanks filled	5 characters
51	Parameter 9 unit	(2) Unit code	1 character
52	Parameter 10 code	(1) Parameter code	2 characters
53	Parameter 10 status	(5) Parameter status code	1 character
54	Parameter 10 error	(6) Parameter error code	1 character
55	Parameter 10 data	5 characters including decimal point, right-justified with blanks filled	5 characters
56	Parameter 10 unit	(2) Unit code	1 character
57	Parameter 11 code	(1) Parameter code	2 characters
58	Parameter 11 status	(5) Parameter status code	1 character
59	Parameter 11 error	(6) Parameter error code	1 character
60	Parameter 11 data	5 characters including decimal point, right-justified with blanks filled	5 characters
61	Parameter 11 unit	(2) Unit code	1 character
62	Parameter 12 code	(1) Parameter code	2 characters
63	Parameter 12 status	(5) Parameter status code	1 character
64	Parameter 12 error	(6) Parameter error code	1 character
65	Parameter 12 data	5 characters including decimal point, right-justified with blanks filled	5 characters
66	Parameter 12 unit	(2) Unit code (6) Parameter error code	1 character
67	Parameter 13 code	(1) Parameter code	2 characters
68	Parameter 13 status	(5) Parameter status code	1 character
69	Parameter 13 error	(6) Parameter error code	1 character
70	Parameter 13 data	5 characters including decimal point, right-justified with blanks filled	5 characters
71	Parameter 13 unit	(2) Unit code	1 character
72	Year	00 to 99	2 characters

73	Month	01 to 12	2 characters
74	Day	01 to 31	2 characters
75	Hour	00 to 23	2 characters
76	Minute	00 to 59	2 characters
77	Second	00 to 59	2 characters
78	Longitude (degrees)	00 to 90 or "--" (no GPS data)	2 characters
79	Longitude (minutes)	00 to 59 or "--" (no GPS data)	2 characters
80	Longitude (seconds)	00 to 59 or "--" (no GPS data)	2 characters
81	Unused	1 character	1 character
82	North latitude/South latitude	N: North; S: South	1 character
83	Latitude (degrees)	000 to 180 or "---" (no GPS data)	3 characters
84	Latitude (minutes)	00 to 59 or "--" (no GPS data)	2 characters
85	Latitude (seconds)	00 to 59 or "--" (no GPS data)	2 characters
86	Unused		1 character
87	East longitude/West longitude	E: East; W: West	1 character
88	Delimiter character		1 character
89	Frame check sequence (FCS)		2 characters

● Memory data requests

● Request command format

```
#  RM X  X  AAAAAAAAAAAAAAAAAAAAAA  XX  XX  XX  @  XX  [CR]  [LF]
1  2  3  4  5                      6  7  8  9  10
```

1	Header		1 character
2	Command		2 characters
3	Data specification ^{*1}	0: Start search; 1: Next data item; 2: Previous data item; 3: Request same data again	1 character
4	Search method specification	0: All data; 1: Site search; 2: Date search	1 character
5	Search site ^{*2}	Upper- and lowercase letters, numbers, periods (.) hyphens (-) and spaces ()	20 characters
6	Search year ^{*3}	00 to 99	2 characters
7	Search month ^{*3}	01 to 12	2 characters
8	Search day ^{*3}	01 to 31	2 characters
9	Delimiter character		1 character
10	Frame check sequence (FCS)		2 characters

*1: When sending the RM command, first send 0 [Start search], then 1 [Next data item], 2 [Previous data item] or 3 [Request same data again].

*2: [Search site] is only needed when [Site search] is specified as the search method. If another search method is specified, fill this field with spaces.

*3: [Search year], [Search month] and [Search day] are only needed when [Date search] is specified as the search method. If another search method is specified, fill this field with spaces.

● Response format

(when data exists)

```

#  RM  AAAAAAAAAAAAAAAAAAAAAA  XX X  X  XXXXX  X
1  2  3                               4  5  6  7      8

XX X  X  XXXXX  X  XX X  X  XXXXX  X  XX X  X  XXXXX  X
9  10 11 12      13 14 15 16 17      18 19 20 21 22      23

XX X  X  XXXXX  X  XX X  X  XXXXX  X  XX X  X  XXXXX  X
24 25 26 27      28 29 30 31 32      33 34 35 36 37      38

XX X  X  XXXXX  X  XX X  X  XXXXX  X  XX X  X  XXXXX  X
39 40 41 42      43 44 45 46 47      48 49 50 51 52      53

XX X  X  XXXXX  X  XX X  X  XXXXX  X  XX X  X  XXXXX  X
54 55 56 57      58 59 60 61 62      63 64 65 66 67      68

XX XX XX XX XX XX XX XX X  X  XXX XX XX X  X  @  XX [CR] [LF]
69 70 71 72 73 74 75 76 77 78 79 80  81 82 83 84 85 86
    
```

1	Header		1 character
2	Command		2 characters
3	Site name	Upper- and lowercase letters, numbers, periods (.) hyphens (-) and spaces ()	20 characters
4	Parameter 1 code	(1) Parameter code	2 characters
5	Parameter 1 selection	0: No selection; 1: Selection made	1 character
6	Parameter 1 error	(6) Parameter error code	1 character
7	Parameter 1 data	5 characters including decimal point, right-justified with blanks filled	5 characters
8	Parameter 1 unit	(2) Unit code	1 character
9	Parameter 2 code	(1) Parameter code	2 characters
10	Parameter 2 selection	0: No selection; 1: Selection made	1 character
11	Parameter 2 error	(6) Parameter error code	1 character
12	Parameter 2 data	5 characters including decimal point, right-justified with blanks filled	5 characters
13	Parameter 2 unit	(2) Unit code	1 character
14	Parameter 3 code	(1) Parameter code	2 characters
15	Parameter 3 selection	0: No selection; 1: Selection made	1 character
16	Parameter 3 error	(6) Parameter error code	1 character
17	Parameter 3 data	5 characters including decimal point, right-justified with blanks filled	5 characters
18	Parameter 3 unit	(2) Unit code	1 character
19	Parameter 4 code	(1) Parameter code	2 characters
20	Parameter 4 selection	0: No selection; 1: Selection made	1 character

21	Parameter 4 error	(6) Parameter error code	1 character
22	Parameter 4 data	5 characters including decimal point, right-justified with blanks filled	5 characters
23	Parameter 4 unit	(2) Unit code	1 character
24	Parameter 5 code	(1) Parameter code	2 characters
25	Parameter 5 selection	0: No selection; 1: Selection made	1 character
26	Parameter 5 error	(6) Parameter error code	1 character
27	Parameter 5 data	5 characters including decimal point, right-justified with blanks filled	5 characters
28	Parameter 5 unit	(2) Unit code	1 character
29	Parameter 6 code	(1) Parameter code	2 characters
30	Parameter 6 selection	0: No selection; 1: Selection made	1 character
31	Parameter 6 error	(6) Parameter error code	1 character
32	Parameter 6 data	5 characters including decimal point, right-justified with blanks filled	5 characters
33	Parameter 6 unit	(2) Unit code	1 character
34	Parameter 7 code	(1) Parameter code	2 characters
35	Parameter 7 selection	0: No selection; 1: Selection made	1 character
36	Parameter 7 error	(6) Parameter error code	1 character
37	Parameter 7 data	5 characters including decimal point, right-justified with blanks filled	5 characters
38	Parameter 7 unit	(2) Unit code	1 character
39	Parameter 8 code	(1) Parameter code	2 characters
40	Parameter 8 selection	0: No selection; 1: Selection made	1 character
41	Parameter 8 error	(6) Parameter error code	1 character
42	Parameter 8 data	5 characters including decimal point, right-justified with blanks filled	5 characters
43	Parameter 8 unit	(2) Unit code	1 character
44	Parameter 9 code	(1) Parameter code	2 characters
45	Parameter 9 selection	0: No selection; 1: Selection made	1 character
46	Parameter 9 error	(6) Parameter error code	1 character
47	Parameter 9 data	5 characters including decimal point, right-justified with blanks filled	5 characters
48	Parameter 9 unit	(2) Unit code	1 character
49	Parameter 10 code	(1) Parameter code	2 characters
50	Parameter 10 selection	0: No selection; 1: Selection made	1 character
51	Parameter 10 error	(6) Parameter error code	1 character
52	Parameter 10 data	5 characters including decimal point, right-justified with blanks filled	5 characters
53	Parameter 10 unit	(2) Unit code	1 character
54	Parameter 11 code	(1) Parameter code	2 characters
55	Parameter 11 selection	0: No selection; 1: Selection made	1 character
56	Parameter 11 error	(6) Parameter error code	1 character
57	Parameter 11 data	5 characters including decimal point, right-justified with blanks filled	5 characters
58	Parameter 11 unit	(2) Unit code	1 character
59	Parameter 12 code	(1) Parameter code	2 characters

60	Parameter 12 selection	0: No selection; 1: Selection made	1 character
61	Parameter 12 error	(6) Parameter error code	1 character
62	Parameter 12 data	5 characters including decimal point, right-justified with blanks filled	5 characters
63	Parameter 12 unit	(2) Unit code	1 character
64	Parameter 13 code	(1) Parameter code	2 characters
65	Parameter 13 selection	0: No selection; 1: Selection made	1 character
66	Parameter 13 error	(6) Parameter error code	1 character
67	Parameter 13 data	5 characters including decimal point, right-justified with blanks filled	5 characters
68	Parameter 13 unit	(2) Unit code	1 character
69	Year	00 to 99	2 characters
70	Month	01 to 12	2 characters
71	Day	01 to 31	2 characters
72	Hour	00 to 23	2 characters
73	Minute	00 to 59	2 characters
74	Second	00 to 5	2 characters
75	Longitude (degrees)	00 to 90 or "--" (no GPS data)	2 characters
76	Longitude (minutes)	00 to 59 or "--" (no GPS data)	2 characters
77	Longitude (seconds)	00 to 59 or "--" (no GPS data)	2 characters
78	Unused		1 character
79	North latitude/South latitude	N: North; S: South	1 character
80	Latitude (degrees)	000 to 180 or "---" (no GPS data)	3 characters
81	Latitude (minutes)	00 to 59 or "--" (no GPS data)	2 characters
82	Latitude (seconds)	00 to 59 or "--" (no GPS data)	2 characters
83	Unused		1 character
84	East longitude/West longitude	E: East; W: West	1 character
85	Delimiter character		1 character
86	Frame check sequence (FCS)		2 characters

When no data exists, or memory is at capacity)

#	RM	@	XX	[CR]	[LF]
1	2	3	4		

1	Header	1 character
2	Command	2 characters
3	Delimiter character\	1 character
4	Frame check sequence (FCS)	2 characters

● Memory data count request

● Request command format

#	RN	@	XX	[CR]	[LF]
1	2	3	4		

1	Header	1 character
2	Command	2 characters
3	Delimiter character\	1 character
4	Frame check sequence (FCS)	2 characters

● Response format

#	RN	XXXXX	@	XX	[CR]	[LF]
1	2	3	4	5		

1	Header	1 character	
2	Command	2 characters	
3	Total data count	0 to 10000	5 characters
4	Delimiter character\	1 character	
5	Frame check sequence (FCS)	2 characters	

● Command parse failure response

#	??	X	XX	X	@	XX	[CR]	[LF]
1	2	3	4	5	6	7		

1	Header	1 character
2	Command	2 characters
3	Command parse failure reason ^{*4}	1 character
4	Received command ^{*5}	2 characters
5	(3) Status code for probe status ^{*5}	1 character
6	Delimiter character	1 character
7	Frame check sequence (FCS)	2 characters

*4: List of command parse failure reasons

- 1: Frame length error
- 2: FCS mismatch
- 3: Undefined command
- 4: Data error
- 5: Data out of range
- 6: No "@" delimiter character
- 7: No "#" header character
- 8: No [Carriage return] + [Line feed] footer
- 9: Cannot accept command in this timing.

*5: Only set for command parse failure reason 9, [Cannot accept command in this timing]. Otherwise this field is filled with spaces.

4 Maintenance

Tip

HORIBA Advanced Techno recommends regular manufacturer maintenance checks in order to ensure a long product life.

4.1 Contact for maintenance

Manufacturer: HORIBA Advanced Techno Co., Ltd.
31, Miyanonishi-cho, Kisshoin Minami-ku, Kyoto 601-8306, Japan

4.2 Routine care

● After measurement

1. Press the control unit's **POWER** key for about 1 second to turn the power **OFF**.

Note

The operation keys are designed to operate using the pad of a finger, sharp objects can tear the control unit cover damaging the operation keys.

2. Remove the sensor guard, and clean the sensor with tap water.
3. Clean the turbidity sensor with the cleaning brush provided.
4. Remove the two screws securing the **COND** guard, and the **COND** guard itself, and use a test tube brush to gently remove any dirt from the electrical conductivity electrode.

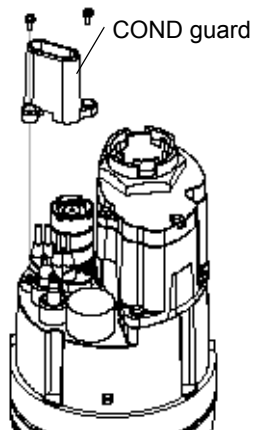

5. Wipe off any dirt with a soft cloth. If parts are very dirty, clean them with neutral detergent, then rinse them. If parts are contaminated by oil, wipe it off with a soft cloth soaked in alcohol.
6. Put the **COND** guard back in place.

-
7. Remove the sensor guard's guard cap, wash off any dirt with tap water, then put the guard cap back in place.

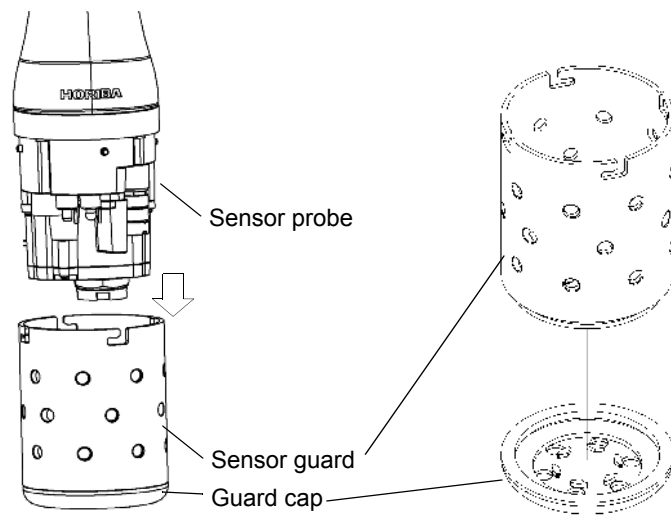

4.3 Every 2 months maintenance

● Dissolved oxygen (DO) sensor

Note

- The DO sensor's internal solution is potassium chloride (KCl). Although KCl is harmless, protective equipment such as gloves and goggles should be worn when working with it.
- Internal solution can be disposed of down a sink.
- Use #306 as the internal solution.

- Replace the membrane cap.
- Polish the gold and silver electrodes when replacing the membrane cap.
The gold electrode does not need to be polished if it is not dirty.

● Silver electrode

Polish a silver electrode part with sandpaper (#600) and then wash metal electrode parts with water.

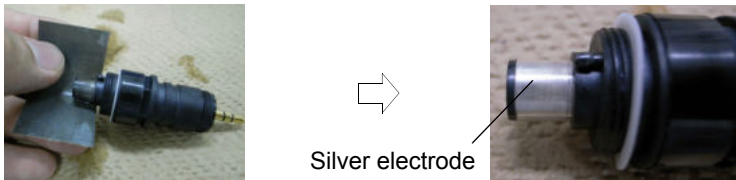

● Gold electrode

Polish a gold electrode part with green polishing sheet (#8000) by the lusterless side. Add water on the green polishing sheet before polishing. And then wash metal electrode parts with water. Do not use sandpaper on the gold electrode.

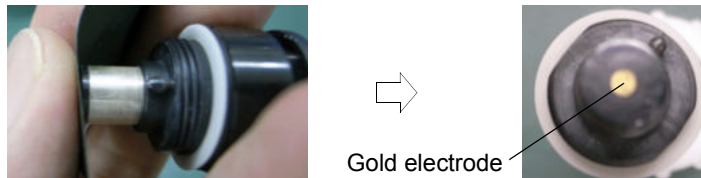

Replace a membrane cap after clean metal electrodes parts.
Refer to “ 4.6 Replacing the membrane cap ” (page 89).

● Reference electrode

Note

- The pH reference internal solution is potassium chloride (KCl). Although KCl is harmless, protective equipment such as gloves and goggles should be worn when working with it.
- Internal solution can be disposed of down a sink.
- Use #330 as the internal solution.

1. Remove the rubber liquid junction plug from the reference electrode and dispose of the internal solution.
2. To prevent air entering, fill the reference electrode to the brim with its internal solution (#330).
3. Put the rubber liquid junction plug back in place.

If the rubber liquid junction plug is dirty, replace the liquid junctions (set of two; No. 3200043587). The reference electrode's internal solution will spill when replacing the liquid junctions. Rinse parts with tap water and dry them with a soft cloth.

4.4 Storage

● Short-term (under 2 months) storage

- Before storing the DO sensor, pour the third of the rubber cap (whit) provided with deionized water and cover the DO sensor with them.

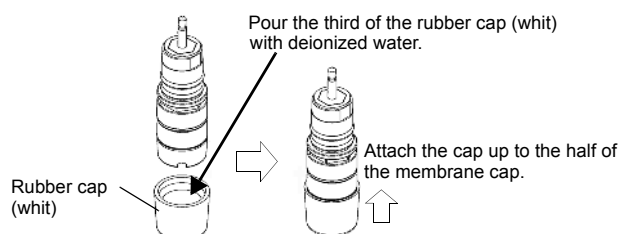

- Before storing the pH sensor, pour the third of the protective cap (blk) provided with deionized water and cover the pH sensor with them.

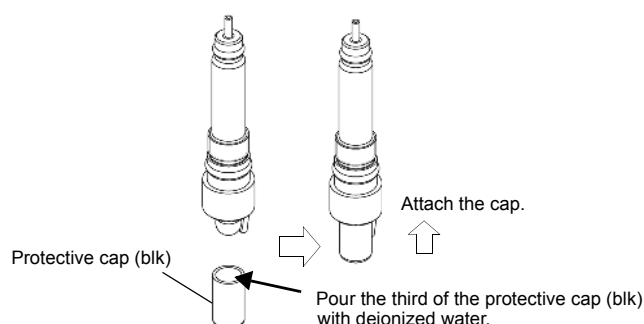

Note

Before measurement, remove the rubber cap (whit) and the protective cap (blk).

● Long-term (2 months or more) storage

- Remove a membrane cap from DO sensor, and wash the gold electrode and silver electrode parts with water. Wipe off the moisture before storing DO sensor in the pack.
- Prevent internal solution seeping out of the reference chip by taping over the point of seepage with electrical tape.
- Before storing the system, remove the control unit's batteries to prevent battery leakage.

4.5 Replacing the turbidity sensor

1. Press the control unit's POWER key for about 1 second to turn the power OFF.

Note

The operation keys are designed to operate using the pad of a finger, sharp objects can tear the control unit cover damaging the operation keys.

2. Remove the sensor guard, and clean the sensor probe with tap water.
3. Use dry air to blow away and dry off any moisture.
4. Remove the three screws holding the turbidity sensor by using No. 2 Phillips head screwdriver.
5. Pull out the turbidity sensor horizontally.
6. Remove the rubber wiper and gasket, and use a soft cloth to wipe off any dirt from the wiper shaft and turbidity sensor attachment. If parts are very dirty, use a soft cloth soaked in neutral detergent or alcohol.
7. Replace the rubber wiper and gasket with new ones. Coat the gasket with a thin layer of grease (No. 3014017718).
8. Attach the new turbidity sensor and fasten it in place with the three screws.
9. Perform four-point calibration before using the sensor.

Note

Do not mistake the combination of sensor probe and turbidity sensor. If the combination is not correct, sensor and sensor probe might be broken. #7800 has to be connected to U-52/U-52G. #7801 has to be connected to U-53/U-53G. #7802 has to be connected to U-54/U-54G.

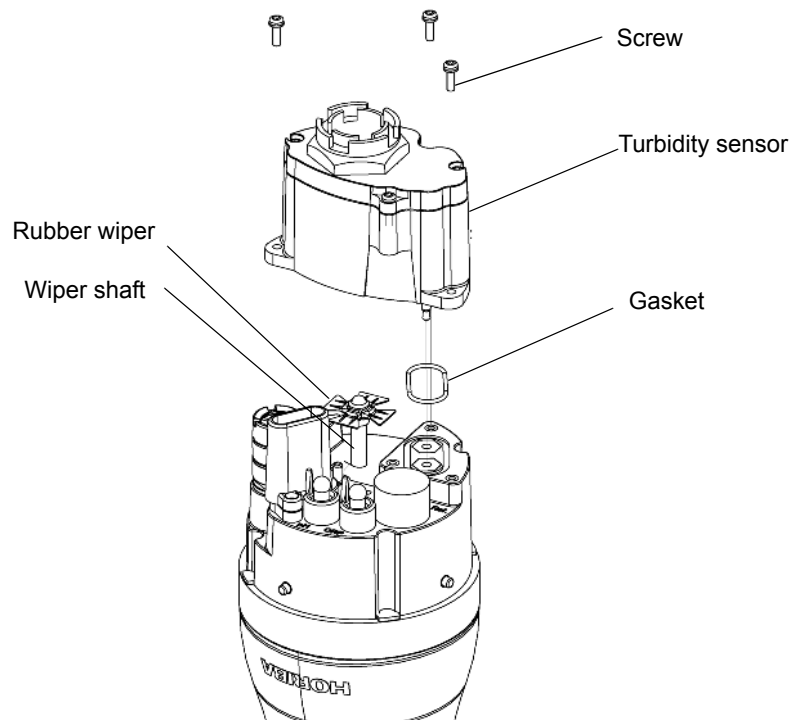

4.6 Replacing the membrane cap

● Replacement procedure

1. Prepare the DO sensor.

- Take a DO sensor out of pack (newly purchasing).
- Remove a DO sensor from the sensor probe (after use).



Newly purchasing



Undo a DO sensor from the sensor probe

- Twist a membrane cap from DO sensor.
- Wash the gold electrode and silver electrode parts with water.

2. Replace the silicone gasket with a new one.

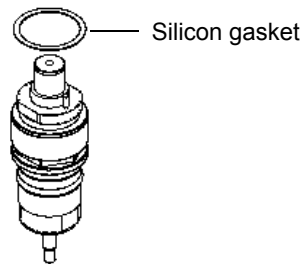

3. Pour internal solution (#306) into a membrane cap with a dropper.

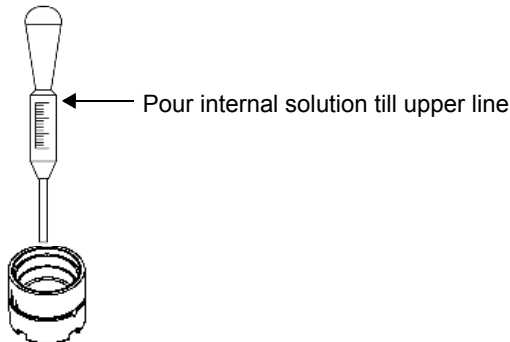

- Check air bubbles in a membrane cap.

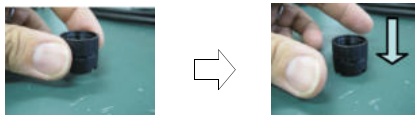

Pick a Cap up and drop it down, if there is air bubbles in internal solution of it.

4. Set up a membrane cap on an adjustable mounting.

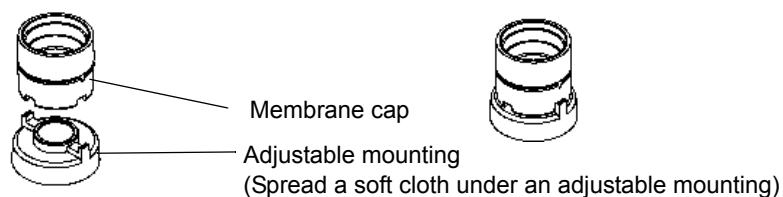

5. Attach a membrane cap to DO sensor

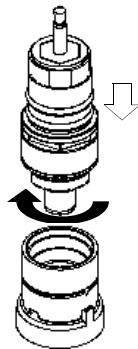

Twist a DO sensor
with holding a membrane cap tight.

6. Check for membrane surface

Check air bubbles in a membrane cap.

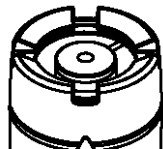

Good: Limited air bubbles

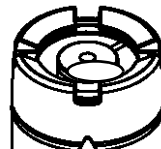

NG: Air bubbles of more than 5 mm in diameter

- NG → Replace a membrane cap again.
- Check that span calibration can be performed.

Note

If the membrane cap is not attached correctly, sensitivity may be lost or response speed may decrease.

4.7 Troubleshooting

Note

If the sensor probe is removed while the control unit is indicating an error, errors cannot be canceled by using the ESC key. Either reconnect the sensor probe or restart the control unit.

4.7.1 Error displays

Error	Cause	Solution
Probe ADC error	Internal IC failure	Contact your nearest sales outlet to have the sensor probe repaired.
Probe EEPROM error/Factory	Internal IC failure	Turn the power OFF, then restart the system. If the error persists, initialize the system from the "System" menu. If the error still persists, contact your nearest sales outlet to have the sensor probe repaired.
Probe EEPROM error/User	Internal IC failure	Turn the power OFF, then restart the system. If the error persists, initialize the system from the "System" menu. If the error still persists, contact your nearest sales outlet to have the sensor probe repaired.
Turbidity sensor light source error	Turbidity sensor light source failure	Turn the power OFF, wipe off any water droplets on the probe, then remove the turbidity sensor. Check there are no water droplets around the turbidity sensor connector, then mount the sensor again. If the error persists, replace the turbidity sensor.
Turbidity sensor wiper motor error	The turbidity sensor wiper is not operating.	Press the ESC key. Check there are no obstacles near the wiper, then perform the measurement again. If the error persists, the motor will need to be replaced. Contact your nearest sales outlet to have the sensor probe repaired.
Probe capacitor error	Low battery voltage or internal IC failure	Turn the power OFF. Replace the display's batteries. If the error persists, contact your nearest sales outlet to have the sensor probe repaired.
Probe EEPROM error	Internal IC failure	Press the ESC key, then redo the operation. If the error persists, turn the power OFF, then restart the system (the current data will not be saved). If the error still persists, contact your nearest sales outlet to have the display repaired.
Probe board error	Probe board failure	Turn the power OFF. Contact your nearest sales outlet to have the sensor probe repaired.

4 Maintenance

Error	Cause	Solution
Zero-point calibration error	<p>pH sensor</p> <ol style="list-style-type: none"> 1. The pH standard solution is contaminated. 2. The pH-responsive membrane is dirty. 3. The concentration of the reference electrode's internal solution has changed. 4. The pH-responsive membrane is torn. 	<p>pH sensor</p> <ol style="list-style-type: none"> 1. Replace the standard solution with new solution. 2. Clean the pH-responsive membrane. 3. Refill the reference electrode's internal solution. 4. Replace the sensor.
	<p>COND sensor</p> <ol style="list-style-type: none"> 1. There is moisture on the sensor. 2. The sensor is dirty. 3. The COND sensor has failed. 	<p>COND sensor</p> <ol style="list-style-type: none"> 1. Blow-dry the moisture off the sensor. 2. Clean the sensor. 3. Contact your nearest sales outlet.
	<p>TURB sensor</p> <ol style="list-style-type: none"> 1. There are air bubbles on the cell. 2. The cell window is dirty. 3. The sensor is being affected by ambient light. 4. The solution is dirty. 5. The TURB sensor has failed. 	<p>TURB sensor</p> <ol style="list-style-type: none"> 1. Shake the sensor probe vigorously. 2. Clean the cell window. 3. Calibrate using the calibration cup provided. 4. Replace the solution with new solution. 5. Replace the TURB sensor.
	<p>DO sensor</p> <ol style="list-style-type: none"> 1. There are air bubbles in the internal solution. 2. The DO sensor has failed. 	<p>DO sensor</p> <ol style="list-style-type: none"> 1. Replace the diaphragm with a new one, and fill the DO sensor with new internal solution. 2. Replace the DO sensor.
	<p>Water depth sensor</p> <ol style="list-style-type: none"> 1. The water depth sensor is dirty. 2. The water depth sensor has failed. 	<p>Water depth sensor</p> <ol style="list-style-type: none"> 1. Clean the water depth sensor. 2. Contact your nearest sales outlet.

Error	Cause	Solution
Span calibration error	<p>pH sensor</p> <ol style="list-style-type: none"> 1. The pH standard solution is contaminated. 2. The pH-responsive membrane is dirty. 3. The concentration of the reference electrode's internal solution has changed. 4. The pH-responsive membrane is torn. 	<p>pH sensor</p> <ol style="list-style-type: none"> 1. Replace the standard solution with new solution. 2. Clean the pH-responsive membrane. 3. Refill the reference electrode's internal solution. 4. Replace the sensor.
	<p>ORP sensor</p> <ol style="list-style-type: none"> 1. The ORP standard solution is contaminated. 2. The ORP electrode is dirty. 3. The concentration of the reference electrode's internal solution has changed. 4. The ORP electrode has failed. 	<p>ORP sensor</p> <ol style="list-style-type: none"> 1. Replace the standard solution with new solution. 2. Clean the ORP electrode. 3. Refill the reference electrode's internal solution. 4. Replace the ORP electrode.
	<p>COND sensor</p> <ol style="list-style-type: none"> 1. The calibration solution is not correct. 2. The sensor is dirty. 3. The COND sensor has failed. 	<p>COND sensor</p> <ol style="list-style-type: none"> 1. Use the correct calibration solution for calibration. 2. Clean the sensor. 3. Contact your nearest sales outlet.
	<p>TURB sensor</p> <ol style="list-style-type: none"> 1. There are air bubbles on the cell. 2. The cell window is dirty. 3. The sensor is being affected by ambient light. 4. The solution is dirty. 5. The TURB sensor has failed. 	<p>TURB sensor</p> <ol style="list-style-type: none"> 1. Shake the sensor probe vigorously. 2. Clean the cell window. 3. Calibrate using the calibration cup provided. 4. Replace the solution with new solution. 5. Replace the TURB sensor.
	<p>DO sensor</p> <ol style="list-style-type: none"> 1. The diaphragm is torn. 2. There are air bubbles in the internal solution. 3. The DO sensor has failed. 	<p>DO sensor</p> <ol style="list-style-type: none"> 1. Replace the diaphragm with a new one, and fill the DO sensor with new internal solution. 2. Replace the diaphragm with a new one, and fill the DO sensor with new internal solution. 3. Replace the DO sensor.
	<p>Temperature sensor</p> <p>The temperature sensor has failed.</p>	<p>Temperature sensor</p> <p>Contact your nearest sales outlet.</p>
Calibration stability error	<p>The calibration value of an individual parameter is not stable.</p> <ol style="list-style-type: none"> 1. The sensor is dirty. 2. The sensor has not adjusted to the standard solution. 3. The temperature was unstable during calibration. 	<ol style="list-style-type: none"> 1. Clean the sensor. 2. Fill the transparent calibration cup with pH 4 standard solution, and wait for at least 20 minutes of conditioning before starting calibration. 3. Start calibration after the temperature has stabilized.
Turbidity calibration error	Error in turbidity measurement sequence	Turbidity calibration failed. Redo calibration after removing the displayed error.
Wet check	The cable connector is submerged.	Turn the power OFF and disconnect the cable connector. Wipe or blow-dry off all the water droplets on the probe. If the error persists, contact your nearest sales outlet to have the display and sensor probe repaired.
Power voltage error	The display's power board has failed.	This error could also be caused by poor cable contact. Turn the power OFF and disconnect the cable connector. Reconnect the connector and turn the power ON. If the error persists, contact your nearest sales outlet to have the display and sensor probe repaired.

4 Maintenance

Error	Cause	Solution
Turbidity lamp power voltage error	The remaining battery level is low.	Turn the power OFF and replace the display's batteries with new ones.
Display RTC error	The time display is incorrect.	Replace the coin battery.
Display FROM error	Internal IC failure	Contact your nearest sales outlet to have the control unit repaired.
Display EEPROM error	Internal IC failure	Contact your nearest sales outlet to have the control unit repaired.
Display save error	Insufficient memory space	Move data from the display, use the data operations screen to delete data, then redo the measurement.
Measurement sequence error	<ul style="list-style-type: none"> ● When the measurement item is turbidity <ol style="list-style-type: none"> 1. The battery power is low. 2. The wiper is not operating normally. 3. The light source lamp is not lit. ● If items other than turbidity are also displayed <ol style="list-style-type: none"> 4. Board failure 	<ol style="list-style-type: none"> 1. Replace the batteries with new ones. 2. Check there are no obstacles near the wiper, then redo the measurement. If the error persists, the motor will need to be replaced. Contact your nearest sales outlet to have the sensor probe repaired. 3. Wipe off any water droplets on the probe, then remove the turbidity sensor. Check there are no water droplets around the turbidity sensor connector, then mount the sensor again. If the error persists, replace the turbidity sensor. 4. Contact your nearest sales outlet to have the sensor probe repaired.
Out of measurement range	The attempted measurement is outside the measurement range supported for that item.	The system must be used within its supported measurement ranges.
Last zero-point calibration invalid	<p>pH sensor</p> <ol style="list-style-type: none"> 1. The pH standard solution is contaminated. 2. The pH-responsive membrane is dirty. 3. The concentration of the reference electrode's internal solution has changed. 4. The pH-responsive membrane is torn. 	<p>pH sensor</p> <ol style="list-style-type: none"> 1. Replace the standard solution with new solution. 2. Clean the pH-responsive membrane. 3. Refill the reference electrode's internal solution. 4. Replace the sensor.
	<p>COND sensor</p> <ol style="list-style-type: none"> 1. There is moisture on the sensor. 2. The sensor is dirty. 3. The COND sensor has failed. 	<p>COND sensor</p> <ol style="list-style-type: none"> 1. Blow-dry the moisture off the sensor. 2. Clean the sensor. 3. Contact your nearest sales outlet.
	<p>TURB sensor</p> <ol style="list-style-type: none"> 1. There are air bubbles on the cell. 2. The cell window is dirty. 3. The sensor is being affected by ambient light. 4. The solution is dirty. 5. The TURB sensor has failed. 	<p>TURB sensor</p> <ol style="list-style-type: none"> 1. Shake the sensor probe vigorously. 2. Clean the cell window. 3. Calibrate using the calibration cup provided. 4. Replace the solution with new solution. 5. Replace the TURB sensor.
	<p>DO sensor</p> <ol style="list-style-type: none"> 1. There are air bubbles in the internal solution. 2. The DO sensor has failed. 	<p>DO sensor</p> <ol style="list-style-type: none"> 1. Replace the diaphragm with a new one, and fill the DO sensor with new internal solution. 2. Replace the DO sensor.
	<p>Water depth sensor</p> <ol style="list-style-type: none"> 1. The water depth sensor is dirty. 2. The water depth sensor has failed. 	<p>Water depth sensor</p> <ol style="list-style-type: none"> 1. Clean the water depth sensor. 2. Contact your nearest sales outlet.
Out of measurement range	[See above.]	[See above.]
Last zero-point calibration invalid	[See above.]	[See above.]

Error	Cause	Solution
Last span calibration invalid	pH sensor 1. The pH standard solution is contaminated. 2. The pH-responsive membrane is dirty. 3. The concentration of the reference electrode's internal solution has changed. 4. The pH-responsive membrane is torn.	pH sensor 1. Replace the standard solution with new solution. 2. Clean the pH-responsive membrane. 3. Refill the reference electrode's internal solution. 4. Replace the sensor.
	ORP sensor 1. The ORP standard solution is contaminated. 2. The ORP electrode is dirty. 3. The concentration of the reference electrode's internal solution has changed. 4. The ORP sensor glass is broken.	ORP sensor 1. Replace the standard solution with new solution. 2. Clean the ORP electrode. 3. Refill the reference electrode's internal solution. 4. Replace the sensor.
	COND sensor 1. The calibration solution is not correct. 2. The sensor is dirty. 3. The COND sensor has failed.	COND sensor 1. Use the correct calibration solution for calibration. 2. Clean the sensor. 3. Contact your nearest sales outlet.
	TURB sensor 1. There are air bubbles on the cell. 2. The cell window is dirty. 3. The sensor is being affected by ambient light. 4. The solution is dirty. 5. The TURB sensor has failed.	TURB sensor 1. Shake the sensor probe vigorously. 2. Clean the cell window. 3. Calibrate using the calibration cup provided. 4. Replace the solution with new solution. 5. Replace the TURB sensor.
	DO sensor 1. The diaphragm is torn. 2. There are air bubbles in the internal solution. 3. The DO sensor has failed.	DO sensor 1. Replace the diaphragm with a new one, and fill the DO sensor with new internal solution. 2. Replace the diaphragm with a new one, and fill the DO sensor with new internal solution. 3. Replace the DO sensor.
	Temperature sensor ● The temperature sensor has failed.	Temperature sensor ● Contact your nearest sales outlet.
Out of measurement range	[See above.]	[See above.]
Last zero-point calibration invalid	[See above.]	[See above.]
Last span calibration invalid	The calibration value of an individual parameter is not stable. 1. The sensor is dirty. 2. The sensor has not adjusted to the standard solution. 3. The temperature was unstable during calibration.	1. Clean the sensors. 2. Fill the transparent calibration cup with pH 4 standard solution, and wait for at least 20 minutes of conditioning before starting calibration. 3. Start calibration after the temperature has stabilized.
Out of measurement range	[See above.]	[See above.]
Last zero-point calibration invalid	[See above.]	[See above.]
Calibration value is factory default value.	Internal IC failure	Turn the power OFF, then restart the system. If the error persists, initialize the system from the "System" menu. If the error still persists, contact your nearest sales outlet to have the sensor probe repaired.

4 Maintenance

Error	Cause	Solution
Sample is unstable.	<ol style="list-style-type: none"> 1. The concentration of the sample is unstable. 2. External light disturbance has affected the sensor. 3. Water has entered the turbidity sensor's connector. 	<ol style="list-style-type: none"> 1. Use a stirrer to agitate the sample during measurement. 2. Perform measurement away from direct sunlight. 3. Turn the power OFF, wipe off any water droplets on the probe, then remove the turbidity sensor. Check there are no water droplets around the turbidity sensor connector, then mount the sensor again. If the error persists, replace the turbidity sensor.

4.7.2 Error displays in sensor information

Error display	Cause	Solution
Measurement sequence error	Measurement sequence error	Turn the power OFF, then restart the system. If the error persists, have the probe repaired.
Out of measurement range	The measurement value is outside the measurement range.	Samples for measurement must be within the measurement range.
Last calibration invalid	The last calibration failed.	Redo calibration.
Calibration invalid	The calibration value is the factory default value.	Redo calibration.
Background unstable	The U-53 turbidity sensor is exposed to direct light.	Mount the guard cap and sensor guard and perform measurement away from direct sunlight.
	The turbidity value changed rapidly during measurement.	Measure a sample that has stable turbidity.

5 Specifications

Specification		Basic value	Model						
			U-51	U-52	U-52G	U-53	U-53G	U-54	U-54G
Sensor probe	Measurement temperature range	-10°C to 55°C							
	Maximum sensor outer diameter	Approx. 96 mm							
	Sensor length	Approx. 340 mm	✓	✓	✓	✓	✓	✓	✓
	Cable length	2 m (standard) 10 m/30 m (options)							
	Mass	Approx. 1800 g							
	Auto calibration function	Uses pH 4 standard solution.							
	Measurement depth	30 m max.							
	Wet-part materials *3	PPS, glass, SUS316L, SUS304, FKM, PEEK, Q, titanium, FEP membrane, POM	✓	✓	✓	✓	✓	✓	✓
	Waterproofing standard	IP-68							
Control unit	Outer dimensions (W × D × H)	115 mm × 66 mm × 283 mm	✓	✓	—	✓	—	✓	—
		115 mm × 66 mm × 335 mm	—	—	✓	—	✓	—	✓
	Mass	Approx. 800 g	✓	✓	✓	✓	✓	✓	✓
	LCD	320 × 240 mm graphic LCD (monochrome) with backlight	✓	✓	✓	✓	✓	✓	✓
	Memory data items	10000	✓	✓	✓	✓	✓	✓	✓
	Communication interface	USB peripheral	✓	✓	✓	✓	✓	✓	✓
	Batteries	C-size dry cells (×4)	✓	✓	✓	✓	✓	✓	✓
	Waterproofing standard	IP-67	✓	✓	✓	✓	✓	✓	✓
	GPS unit	<ul style="list-style-type: none"> ● Reception method (12 channel parallel) ● Measurement precision [With PDOP (high precision): 30 m or less (2 drms)] 	—	—	✓	—	✓	—	✓
	Estimated battery life *1	—	70 hours (no backlight)			500 measurements (no backlight)		70 hours (no backlight)	
	Storage temperature range	-10°C to 60°C	✓	✓	✓	✓	✓	✓	✓
Ambient temperature range	-5°C to 45°C								

5 Specifications

Specification		Basic value	Model						
			U-51	U-52	U-52G	U-53	U-53G	U-54	U-54G
pH measurement Two calibration	Measurement method	Glass electrode method							
	Range	pH 0 to 14	✓	✓	✓	✓	✓	✓	✓
	Resolution	0.01 pH							
	Precision *2	±0.1 pH							
Dissolved oxygen measurement ● Salinity conversion (0 to 70 PPT, automatic) ● Automatic temperature compensation	Measurement method	Polarographic method							
	Film thickness	25 µm							
	Range	0 mg/L to 50.0 mg/L							
	Resolution	0.01 mg/L	✓	✓	✓	✓	✓	✓	✓
Precision *2	0 mg/L to 20 mg/L: ±0.2 mg/L 20 mg/L to 50 mg/L: ±0.5 mg/L								
Electrical conductivity measurement ● Auto range ● Automatic temperature conversion (25°C)	Measurement method	Four-AC-electrode method							
	Range	0 S/m to 10 S/m (0 mS/cm to 100 mS/cm)							
	Resolution	0.000 mS/cm to 0.999 mS/cm: 0.001 1.00 mS/cm to 9.99 mS/cm: 0.01 10.0 mS/cm to 99.9 mS/cm: 0.1 0.0 mS/m to 99.9 mS/m: 0.1 0.100 S/m to 0.999 S/m: 0.001 1.00 S/m to 9.99 S/m: 0.01	✓	✓	✓	✓	✓	✓	✓
	Precision *2	1% of full-scale (midpoint of two calibration points)							
Salinity measurement	Measurement method	Electrical conductivity conversion							
	Range	0 PPT to 70 PPT (parts per thousand)	✓	✓	✓	✓	✓	✓	✓
	Resolution	0.1 PPT							
	Precision	±3 PPT							
TDS (total dissolved solid) measurement ● Conversion coefficient setting	Measurement method	Electrical conductivity conversion							
	Range	0 g/L to 100 g/L	✓	✓	✓	✓	✓	✓	✓
	Resolution	0.1% of full-scale							
	Repeatability	±2 g/L							
Precision	±5 g/L								
Seawater specific gravity measurement ● σt, σ0, σ15 display	Measurement method	Electrical conductivity conversion							
	Range	0 σt to 50 σt	✓	✓	✓	✓	✓	✓	✓
	Resolution	0.1 σt							
	Precision	±5 σt							

Specification		Basic value	Model						
			U-51	U-52	U-52G	U-53	U-53G	U-54	U-54G
Temperature measurement	Measurement method	Platinum temperature sensor							
	Range	-10°C to 55°C	✓	✓	✓	✓	✓	✓	✓
	Resolution	0.01°C							
	Sensor	Platinum temperature sensor, JIS Class B (0.3 + 0.005 t)							
Turbidity measurement	Measurement method			LED forward 30° transmission/scattering method		Tungsten lamp 90° transmission/scattering method		LED 90° scattering method	
	Range			0 NTU to 800 NTU		0 NTU to 1000 NTU		0 NTU to 1000 NTU	
	Resolution			0.1 NTU		0.01 NTU		0.01 NTU	
	Precision*2		-	±5% of read-out or ±1 NTU, whichever is larger		<ul style="list-style-type: none"> ● ±0.5 NTU (for 0 NTU to 10 NTU measurement range) ● 3% of readout or 1 NTU, whichever is larger (for 10 NTU to 1000 NTU measurement range) 		±5% of read-out or ±1 NTU, whichever is larger	
	Turbidity sensor wiper			-		✓		-	
Water depth measurement	Measurement method	Pressure method							
	Range	0 m to 30 m	-	-	✓	✓	✓	2 m: - 10 m, 30 m: ✓	
	Resolution	0.05 m							
	Precision*2	±0.3 m							
ORP (oxidation reduction potential) measurement	Measurement method	Platinum electrode method							
	Range	-2000 mV to +2000 mV	✓	✓	✓	✓	✓	✓	
	Resolution	1 mV							
	Precision*2	±15 mV							

*1: Battery life is estimated under following conditions.

- Continuous operation
- Using batteries: C-size alkaline dry cells
- Ambient temperature of the control unit: 20°C or more
- Backlight off

- *2: The precision is defined by measuring the standard solution in the following cases.
 - Turbidity and conductivity: after four point calibration
 - pH and DO: after two point calibration
 - Water depth and ORP: after one point calibration
- *3: Metallic parts are made of stainless steel. Immersing in seawater may erode metallic parts.

6 Reference

6.1 Consumable parts

● Sensor

Name	Model	No.	Description
pH sensor	#7112	3014057312	Standard type pH sensor
pH sensor ToupH	#7113	3200170923	Tough glass type pH sensor
ORP sensor	#7313	3200170920	
DO sensor	#7543	3200170924	
Reference electrode	#7210	3200043582	
R bush unit	—	3200043587	Reference electrode liquid junction
TURB sensor U-52	#7800	3200172803	For U-52/U-52G
TURB sensor U-53	#7801	3200172800	For U-53/U-53G
TURB sensor U-54	#7802	3200318188	For U-54/U-54G
Membrane cap	—	3200170194	For DO sensor

● Standard solution and inner solution

Name	Model	No.	Description
pH 4 (For automatic calibration) 500 mL	#100-4	3200043638	Standard solution for auto calibration. Also used for manual pH span calibration.
pH 4 (For automatic calibration) 4 L	#140-4	3200174430	
pH 7 500 mL	#100-7	3200043637	Standard solution for pH zero-point calibration. Actual pH value is 6.86 at 25°C
pH 9 500 mL	#100-9	3200043636	Standard solution for pH manual span calibration.
Powder for ORP standard solution 10 packs	#160-51	3200043618	For ORP calibration.
Powder for ORP standard solution 10 packs	#160-22	3200043617	
Inner solution for DO sensor, 50 mL	#306	3200170938	Internal solution for DO sensor.
Internal solution for pH, 250 mL	#330	3200043641	Supplementary internal solution for pH reference electrode.

● Others

Name	Model	No.	Description
Silicone grease	—	3014017718	Silicone grease for coating sensor O-ring.
Sponge brush unit	—	3200169531	Brush for cleaning sensor probe.
O-ring set for reference electrode	—	3200169376	O-rings for reference electrode.
O-ring set for DO sensor	—	3200169426	O-rings for DO sensor.
Rubber cap set for sensor guard	—	3200169428	Rubber caps used between sensor guard and sensor probe.
O-ring set for pH and ORP sensor	—	3200169520	O-rings for pH and ORP sensors.
Wiper unit	—	3200169789	Rubber wiper for U-53/U-53G turbidity sensors.
Protective cap (blk) for pH sensor	—	3200175019	Cap attached to tip of pH sensor for sensor probe storage.
Rubber cap (whit) for DO sensor	—	3200175020	Cap attached to tip of DO sensor for sensor probe storage.

6.2 Options sold separately

Name	Model	No.	Description
Bag	U-5030	3200174772	Storage bag for sensor probes and flow cell. Can be carried in one hand.
Flow cell	—	3200156570	Used when collecting measurement samples by pump.
Probe guard	—	3200167002	Used for taking measurements in locations where there is a current or where there is a thick layer of sludge.
Communication cable	—	3200174823	A PC connection cable. Comes with data collection software.

6.3 pH measurement

6.3.1 Principle of pH measurement

U-50 series use the glass electrode method for pH measurements. The glass electrode method measures a potential difference between the glass film for pH and the reference electrode. For more information, refer to “JIS Z 8802 pH measurement method”.

6.3.2 Temperature compensation

The electromotive force generated by the glass electrode changes depending on the temperature of the solution.

Temperature compensation is used to compensate for the change in electromotive force caused by temperature.

This function does not compensate the change in pH caused by the temperature of the solution. When pH is to be measured, the temperature of the solution must be recorded along with that pH value, even if a pH meter has automatic temperature compensation function. If the solution temperature is not recorded, the results of the pH measurement may be meaningless.

6.3.3 Standard solutions

When measuring pH, the pH meter must be calibrated using standard solution. There are five kinds of standard solutions specified in “JIS Z 8802 pH measurement”. For normal measurement, two of standard solutions with pH of 4, 7, and 9 are sufficient to accurately calibrate the meter.

For standard solutions, refer to “JIS Z 8802 pH measurement”.

- pH 4 standard solution: 0.05 mol/L potassium hydrogen phthalate aqueous solution (Phthalate)
 pH 6.86 standard solution: 0.025 mol/L potassium dihydrogenphosphate, 0.025 mol/L disodium hydrogenphosphate aqueous solution (Neutral phosphate)
 pH 9 standard solution: 0.01 mol/L sodium tetraborate aqueous solution (Borate)

Table 4 pH values of HORIBA pH standard solutions at various temperatures settings

Temp. (°C)	pH 4 standard solution Phthalate	pH 6.86 standard solution Neutral phosphate	pH 9 standard solution Borate
0	4.01	6.98	9.46
5	4.01	6.95	9.39
10	4.00	6.92	9.33
15	4.00	6.90	9.27
20	4.00	6.88	9.22
25	4.01	6.86	9.18
30	4.01	6.85	9.14
35	4.02	6.84	9.10
40	4.03	6.84	9.07
45	4.04	6.84	9.04

Table 5 Indicated value of other pH standard solutions at various temperatures (pH)

Temp. (°C)	pH 7 standard solution Neutral phosphate	pH 10 standard solution Carbonate
0	7.12	10.32
5	7.09	10.25
10	7.06	10.18
15	7.04	10.12
20	7.02	10.06
25	7.00	10.01
30	6.99	9.97
35	6.98	9.93
40	6.97	9.89
45	6.97	9.86

6.4 DO measurement

6.4.1 Principle of DO measurement

Dissolved oxygen (DO) refers to the amount of oxygen that is contained in water.

The concentration of dissolved oxygen is generally given as mg/L or as a percentage value (the dissolved oxygen saturation ratio).

Dissolved oxygen is essential for maintaining the self-purifying ability of rivers and seas and also for fish to live. The concentration of dissolved oxygen acts as an indicator of water quality. It is often measured when processing waste water and managing water quality. Fig. 1 provides an overview of the principles behind dissolved oxygen sensor measurement.

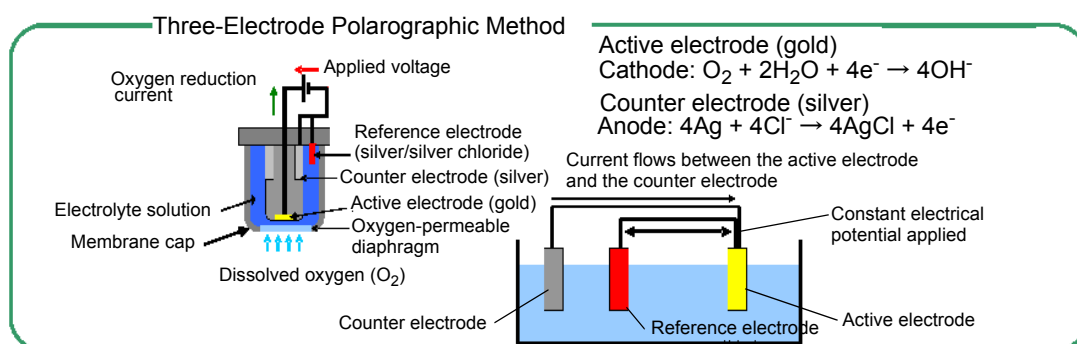

Fig. 1 Overview of principles behind dissolved oxygen sensor

The polarographic oxygen sensor is an enclosed sensor wherein voltage is applied to a cathode made of a precious metal (such as gold or platinum) and an anode also made of a precious metal (such as silver) via an external circuit, and a cap with an oxygen permeable diaphragm (membrane) is filled with electrolyte solution. As indicated in Fig. 1, the concentration of dissolved oxygen can be measured by measuring the current proportional to the amount of reduced oxygen when oxygen that has dispersed through the oxygen permeable diaphragm produces a reductive reaction on the surface of the active electrode (gold). The method of measuring dissolved oxygen based on the above principle is called the Membrane Electrode Method. Compared to the Chemical Analysis Method, which requires complicated pre-processing to alleviate the effect of reduced materials and oxidizing materials, this method allows dissolved oxygen to be measured very easily. It is also easy to remove undesired buildup from the silver electrode by polishing and cleaning if an insulator forms on it due to oxidation, making the method reusable.

6.4.2 Conditioning of DO sensor

Oxygen goes into membrane cap of DO sensor through membrane without being consumed by the sensor while U-50's power is off, although polarographic DO sensor consumes oxygen during the measurement. DO value is higher than usual after turning U-50's power on because DO sensor is measuring and consuming extra oxygen.

For the easy maintenance, U-50's DO sensor has a big membrane cap and space for oxygen, so conditioning time is a little long.

6.4.3 Salinity calibration

When the solution and air come into contact and form an equilibrium (i.e. saturation), the relationship between the concentration of dissolved oxygen in the solution, C , [mol/L], and the partial pressure of oxygen in the air, P_s , [MPa/(mg/L)], can be represented by the following formula:

$$C = P_s/H$$

Where H [MPa/(mg/L)] is the Henry constant, a value that changes according to the composition of the solution. As H typically becomes larger as the salinity of the water increases, C becomes smaller.

The DO sensor detects the partial pressure of oxygen (P_s) in the above formula. Accordingly, if the DO sensor is immersed in deionized water saturated with air, or in an aqueous solution containing salt, the output current does not change, resulting in an erroneous measurement. For example, when salt is added to a sample, the amount of oxygen that can be dissolved in the solution decreases, but because the partial pressure of oxygen does not change, the value displayed by the control unit stays the same regardless of salt content. This concept is indicated in graph form below. (Fig. 2)

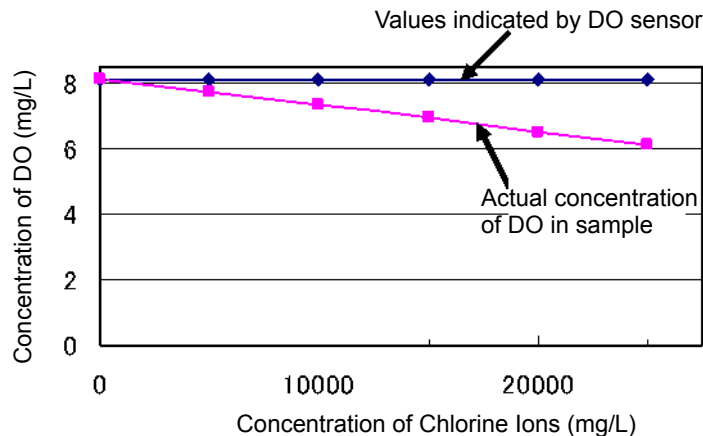

Fig. 2 Relationship between chlorine ion concentration and dissolved oxygen concentration

In samples with a high salt concentration, the solubility of oxygen is lower, but as the partial pressure of oxygen does not change, the value actually indicated on the control unit is higher than the actual value. In order to obtain a measurement of the concentration of dissolved oxygen in an aqueous solution that contains salt, it is therefore necessary to first perform salinity compensation. Conventionally, dissolved oxygen sensors have performed salinity compensation by inputting the salinity of the sample. This is fine as long as the salinity is already known. However, in most cases salinity is unknown, so even if dissolved oxygen sensors contained a salinity compensation function, it was of no practical use.

The U-50 Series can calculate and measure salinity in samples from electrical conductivity values, and can thus be used to automatically compensate for salinity.

6.4.4 Atmospheric pressure compensation (DO) - Relation of altitude and air pressure

General relation of altitude and air pressure is shown below.

Table 6 Relation of altitude and air pressure (m)

Altitude (m)	Air pressure (Torr)	Air pressure (bar)	Air pressure (atm)	Air pressure (hPa)
0	760	1.013	1.000	1013
100	751	1.001	0.988	1001
200	742	0.990	0.977	990
300	733	0.978	0.965	978
400	725	0.966	0.953	966
500	716	0.955	0.942	955
600	707	0.943	0.931	943
700	699	0.932	0.920	932
800	691	0.921	0.909	921
900	682	0.910	0.898	910
1000	674	0.899	0.887	899
1100	666	0.888	0.876	888
1200	658	0.877	0.866	877
1300	650	0.867	0.855	867
1400	642	0.856	0.845	856
1500	634	0.846	0.834	846
1600	626	0.835	0.824	835
1700	619	0.825	0.814	825
1800	611	0.815	0.804	815
1900	604	0.805	0.794	805
2000	596	0.795	0.785	795
2100	589	0.785	0.775	785
2200	582	0.776	0.765	776
2300	574	0.766	0.756	766
2400	567	0.756	0.746	756
2500	560	0.747	0.737	747
2600	553	0.738	0.728	738
2700	546	0.728	0.719	728
2800	540	0.720	0.710	720
2900	532	0.710	0.701	710
3000	526	0.701	0.692	701
3200	513	0.684	0.675	684
3400	500	0.667	0.658	667
3600	487	0.649	0.641	649
3800	475	0.633	0.624	633
4000	462	0.617	0.608	617
4200	450	0.601	0.593	601
4400	439	0.585	0.577	585
4600	427	0.569	0.562	569

Table 7 Relation of altitude and air pressure (ft)

Altitude (ft)	Air pressure (psia)	Air pressure (inHg)	Air pressure (hPa)
0	14.70	29.92	1013
100	14.64	29.81	1009
200	14.59	29.70	1006
300	14.53	29.60	1002
400	14.48	29.49	998
500	14.42	29.38	994
600	14.37	29.28	991
700	14.32	29.17	987
800	14.26	29.07	983
900	14.21	28.96	980
1000	14.16	28.86	976
1100	14.11	28.75	973
1200	14.06	28.65	969
1300	14.01	28.54	966
1400	13.96	28.44	962
1500	13.91	28.33	959
1600	13.86	28.23	956
1700	13.81	28.13	952
1800	13.76	28.02	949
1900	13.71	27.92	945
2000	13.66	27.82	942
2100	13.61	27.72	938
2200	13.56	27.62	935
2300	13.51	27.51	931
2400	13.46	27.41	928
2500	13.41	27.31	924
2600	13.36	27.21	921
2700	13.31	27.11	918
2800	13.26	27.01	914
2900	13.21	26.91	911
3000	13.16	26.81	907
3100	13.11	26.71	904
3200	13.06	26.61	900
3300	13.02	26.52	898
3400	12.97	26.42	894
3500	12.92	26.32	891
3600	12.87	26.22	887
3700	12.82	26.13	884
3800	12.78	26.03	881
3900	12.73	25.94	878
4000	12.68	25.84	874
4100	12.63	25.74	871

Altitude (ft)	Air pressure (psia)	Air pressure (inHg)	Air pressure (hPa)
4200	12.59	25.65	868
4300	12.54	25.55	865
4400	12.50	25.46	862
4500	12.45	25.36	858
4600	12.40	25.27	855
4700	12.36	25.17	852
4800	12.31	25.08	849
4900	12.27	24.98	846
5000	12.22	24.89	842
5100	12.17	24.80	839
5200	12.13	24.71	836
5300	12.08	24.61	833
5400	12.04	24.52	830
5500	11.99	24.43	827
5600	11.95	24.34	824
5700	11.90	24.25	820
5800	11.86	24.16	818
5900	11.81	24.07	814
6000	11.77	23.98	811
7000	11.33	23.09	781
8000	10.91	22.22	752
9000	10.50	21.38	724
10000	10.10	20.58	696
11000	9.71	19.75	669

6.5 Conductivity (COND) measurement

6.5.1 Four-AC-electrode method

Conductivity is an index of the flow of electrical current in a substance.

Salts dissolved in water are separated into cations and anions. Such solution is called electrolytic solution.

Electrolytic solution has the property of allowing the flow of current according to Ohm's law. This property is referred

to as ionic conductivity, since current flow is caused by ion movement in electrolytic solution.

Metals, on the other hand, allow the flow of current by means of electrons. This property is called electronic conductivity,

which is distinguished from ionic conductivity.

A cube with 1 m on each side, as shown in Fig. 3, is used to demonstrate an electrolytic solution. Two electrode plates are placed on opposite sides, and the cube is filled with solution. If the resistance between these two electrode plates is represented by $r(\Omega)$, the conductivity of the solution $L(\text{S}\cdot\text{m}^{-1})$ is represented as $L=1/r$. S stands for Siemens, a unit of measurement of conductance.

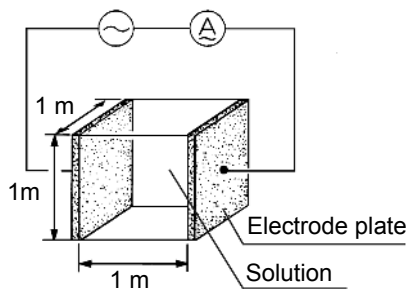

Fig. 3 Definition of conductivity

The most general method for measuring conductivity is based on the above principle, and is called the 2-electrode method.

In the 2-electrode method the influence of polarization cannot be ignored for solutions with high conductivity and conductivity cannot be measured accurately. In addition, contamination on the surface of the electrode increases apparent resistance, resulting in inaccurate measurement of conductivity.

The U-50 series has adopted the 4-electrode method to overcome these disadvantages of the 2-electrode method.

As shown in Fig. 4, the U-50 series uses two voltage-detecting electrodes and two voltage-applying electrodes, for a total of four electrodes. The voltage-detecting electrodes are for detecting AC voltage, and the voltage-applying electrodes are for applying AC voltage.

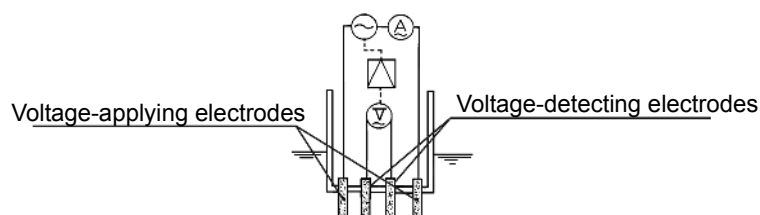

Fig. 4 Principle of the 4-electrode method

Let us assume that the current, $I(A)$, flows in a sample of conductivity L – under automatic control of the voltage-applying electrodes – so that the voltage at the voltage-detecting-electrodes, $E(V)$, remains constant at all times.

Then, the resistance of the sample, $R(\Omega)$, across the voltage-detecting electrodes is represented as $R=E/I$. The resistance, R , of the sample is inversely proportional to its conductivity, L . Accordingly, a measurement of current, I_s ,

of a standard solution of known conductivity, L_s , enables calculation of conductivity of a sample according to the formula $L = L_s (I/I_s)$ from the ratio $L : L_s = I : I_s$.

Even in the 4-electrode method, polarization occurs, since AC current flows in the voltage-applying electrodes. The voltage-detecting electrodes are, however, free from the effects of polarization, since they are separated from the voltage-applying electrodes, and furthermore, current flow is negligible. Therefore, the 4-electrode method is an excellent method to enable measurement of conductivity covering a very high range.

6.5.2 SI units

New measurement units, called SI units, have been in use from 1996. Accordingly, the U-50 series also uses SI units. The following conversion table is provided for people who use the conventional kind of conductivity meter.

Note that along with the change in unit systems, the measurement values and cell counts have also changed.

	Former units	→	SI unit
Measurement value	0.1 mS/cm	→	0.01 S/m
	1 mS/cm	→	0.1 S/m
	100 mS/cm	→	10 S/m

6.5.3 Temperature coefficient

In general, the conductivity of a solution varies largely with its temperature.

The conductivity of a solution depends on the ionic conductivity, described earlier. As the temperature rises, conductivity becomes higher since the movement of the ions becomes more active.

The temperature coefficient shows the change in % of conductivity per °C, with a certain temperature taken as the reference temperature. This is expressed in units of %/°C. The temperature coefficient assumes the premise that the conductivity of a sample changes linearly according to temperature.

Strictly speaking, with actual samples, however, conductivity changes along a curve. Furthermore, the curve varies with the type of sample. In the ranges of smaller temperature changes, however, samples are said to have the temperature coefficient of 2%/°C (at reference temperature 25°C); this holds for most samples, except in certain special cases.

(The temperature coefficients for various types of solutions are listed on the next page.)

The U-50 series uses an automatic temperature conversion function to calculate conductivity at 25°C at a temperature

coefficient of 2 %/°C based on the measured value of the temperature. Results are displayed on the readout.

The U-50 series temperature conversion function is based on the following formula.

$$L_{25} = L_t / \{ 1 + K (t - 25) \}$$

L_{25} : Conductivity of solution converted to 25°C

t : Temperature of solution at time of measurement (°C)

L_t : Conductivity of solution at t (°C)

K : Temperature coefficient (%/°C)

● **Conductivity and temperature coefficient for various solutions**

Conductivity and related temperature coefficients of representative substances (at 25°C) are shown in the table below.

Substance	Temp. (°C)	Conc. (wt%)	Cond. (S/m)	Temp.coef. (%/°C)	Substance	Temp. (°C)	Conc. (wt%)	Cond. (S/m)	Temp.coef. (%/°C)		
NaOH	15	5	19.69	2.01	NaCl	18	5	6.72	2.17		
		10	31.24	2.17			10	12.11	2.14		
		15	34.63	2.49			15	16.42	2.12		
		20	32.70	2.99			20	19.57	2.16		
		30	20.22	4.50			25	21.35	2.27		
		40	11.64	6.48			5	4.09	2.36		
KOH	15	25.2	54.03	2.09	Na ₂ SO ₄	18	10	6.87	2.49		
		29.4	54.34	2.21			15	8.86	2.56		
		33.6	52.21	2.36			Na ₂ CO ₃	18	5	4.56	2.52
		42	42.12	2.83					10	7.05	2.71
NH ₃	15	0.1	0.0251	2.46	KCl	18	15	8.36	2.94		
		1.6	0.0867	2.38			5	6.90	2.01		
		4.01	0.1095	2.50			10	13.59	1.88		
		8.03	0.1038	2.62			15	20.20	1.79		
		16.15	0.0632	3.01			20	26.77	1.68		
HF	18	1.5	1.98	7.20	KBr	15	21	28.10	1.66		
		4.8	5.93	6.66			5	4.65	2.06		
		24.5	28.32	5.83			10	9.28	1.94		
HCl	18	5	39.48	1.58	KCN	15	20	19.07	1.77		
		10	63.02	1.56			3.25	5.07	2.07		
		20	76.15	1.54			6.5	10.26	1.93		
		30	66.20	1.52			—	—	—		
H ₂ SO ₄	18	5	20.85	1.21	NH ₄ Cl	18	5	9.18	1.98		
		10	39.15	1.28			10	17.76	1.86		
		20	65.27	1.45			15	25.86	1.71		
		40	68.00	1.78			20	33.65	1.61		
		50	54.05	1.93			25	40.25	1.54		
		60	37.26	2.13	NH ₄ NO ₃	15	5	5.90	2.03		
		80	11.05	3.49			10	11.17	1.94		
		100.14	1.87	0.30			30	28.41	1.68		
		—	—	—			50	36.22	1.56		
HNO ₃	18	6.2	31.23	1.47	CuSO ₄	18	2.5	10.90	2.13		
		12.4	54.18	1.42			5	18.90	2.16		
		31	78.19	1.39			10	32.00	2.18		
		49.6	63.41	1.57			15	42.10	2.31		
		62	49.64	1.57			10	15.26	1.69		
H ₃ PO ₄	15	10	5.66	1.04	CH ₃ COOH	18	15	16.19	1.74		
		20	11.29	1.14			20	16.05	1.79		
		40	20.70	1.50			30	14.01	1.86		
		45	20.87	1.61			40	10.81	1.96		
		50	20.73	1.74			60	4.56	2.06		

6.6 Salinity (SAL) conversion

The U-50 series is designed to calculate salinity as well as the other parameters.

Note that the "salinity" here is the salinity of sea water. There is a constant relation between conductivity and salinity at certain temperatures.

Therefore, if data on the conductivity and temperature are available, the corresponding salinity can be known. In other words, the salinity measurement of the U-50 series is based on the principle of calculating the salt content, making use of the measured values of conductivity and temperature.

Note therefore, that measured results of all substances whose conductivity is detected are displayed as salinity. For example, the measured result is displayed as NaCl concentration, even if in fact the sample component is, hydrochloric acid (HCl).

6.7 TDS conversion

TDS is short for Total Dissolved Solids and means the total dissolved solid amount.

The conductivity of a solution is affected by the amount of salinity, minerals, and dissolved gases. That is, conductivity is an index that shows the total amount of all substances in the solution. Of these substances, TDS indicates only the amount of dissolved solids.

TDS can be used for a comparison of the state of substances composed of a single component such as NaCl. However, the use of TDS for the comparison of solutions of different types causes serious errors.

Conductivity and TDS are expressed by the following formulas.

Conductivity in SI units (S/m) TDS(g/L) = L (S/m) × K × 10

TDS(g/L) = L (mS/m) × K ÷ 100

Conductivity in the old units (mS/cm) TDS(g/L) = L (mS/cm) × K

K = TDS coefficient

Initial settings use the values listed in the table (Page 80) that generally uses TDS coefficients.

For accurate TDS comparisons, find the TDS coefficient from measured conductivity values. Then set the value thus obtained and make measurements.

6.8 σ_t conversion

● Specific gravity of seawater

The density and specific gravity of seawater are equal numerically and generally are not distinguished strictly. Since seawater density ρ is between 1.000 and 1.031, 1 is subtracted from ρ and σ is obtained by multiplying the value by 1000.

The resultant value is used as the specific gravity of seawater.

$$\sigma = (\rho - 1) \times 1000$$

The density of seawater ρ is expressed by function of temperature, hydraulic pressure, and salinity. The density of seawater under the atmospheric pressure is expressed as σ_t . The density of seawater under the atmospheric pressure is determined by temperature and salinity.

The U-50 Series models make salinity measurement through temperature measurements and conductivity conversion and find σ_t through calculations.

In Japan σ_{15} at 15°C is called a standard specific gravity and widely used while in foreign countries σ_0 at 0°C is employed. σ_{15} and σ_0 are determined by the function of salinity.

In ocean surveys, in particular, these values σ_t , σ_{15} , and σ_0 are more widely used than conductivity and salinity and, in the U-50 Series models, newly added as measurement components.

6.9 Turbidity (TURB) measurement

6.9.1 Principle of turbidity measurement

U-52 and U-53 sensors measure turbidity using the Transmitting and Scattering Method. U-52 sensors use a pulse light LED (infra-red emitting diode) as a light source, and detect scattered light from a 30° angle off center. U-53 sensors use a tungsten lamp as a light source and detect scattered light from a 90° angle. Both models display turbidity as a ratio of scattered light to transmitted light to reduce the affect of the color of the sample. The U-53 method conforms to EPA Method 180.1, and employs wipers to reduce the affect of air bubbles.

U-54 uses a pulse light LED (infra-red diode) as a light source, and detect scattered light from a 90° angle. The U-54 method conforms to EN ISO 7027.

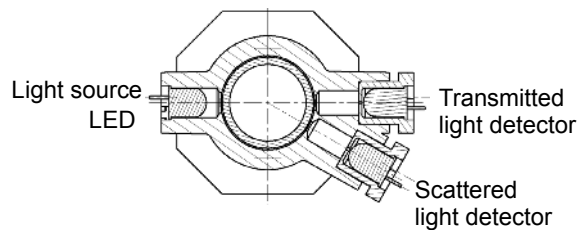

Fig. 5 U-52 turbidity sensor

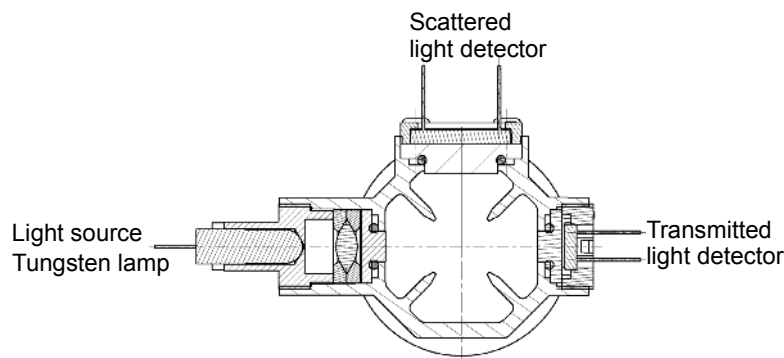

Fig. 6 U-53 turbidity sensor

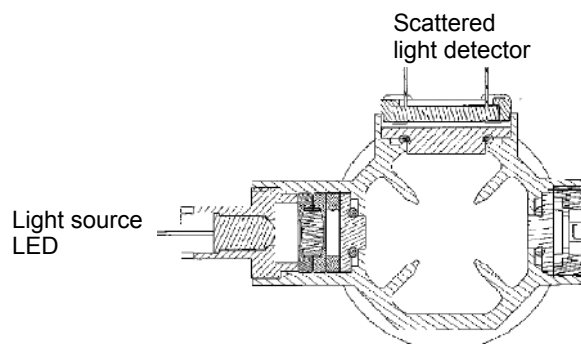

Fig. 7 U-54 turbidity sensor

6.9.2 Standard solution

U-50 series can perform calibration using formazin (NTU) or kaolin standard solutions as a turbidity standard solution. However, units for the solution used for calibration should be displayed in measurements. Do not use more than 400 mg/L of kaolin standard solution because it increases precipitation speed, resulting in measurement error.

6.10 Depth (DEPTH) measurement

6.10.1 Principle of depth measurement

For the U-50 series, depth measurement can be made through use of a pressure gauge. The principle of the depth measurement uses the relation between depth and pressure.

Although the measurement with the depth sensor is affected by atmospheric pressure, the depth sensor, however, makes zero-point adjustments through the automatic calibration before measurements.

6.10.2 Influence of temperature and calibration

The depth sensor depends greatly on temperature. For a wide difference between the temperature at which the sensor has been automatically calibrated and the temperature of the measurement sample, the sensor can make depth measurements with a higher accuracy by the following method:

1. Immerse the depth sensor of the sensor probe in the sample.
2. Keep the sensor immersed in the sample for about 30 minutes until the temperatures of the sensor and the sample are the same.
3. Then make the zero calibration of the sensor manually.

6.11 Oxidation reduction potential (ORP) measurement

6.11.1 Principle of ORP measurement

ORP is an abbreviation for oxidation-reduction potential. ORP is the energy level (potential) determined according to the state of equilibrium between the oxidants (M^{Z+}) and reductants $M^{(Z-N)+}$ that coexist within a solution.

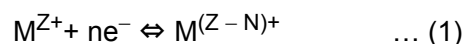

If only the solution, forming the ORP measuring system shown in Fig. 8. The difference of potential between two electrodes is generally expressed by the following equation.

$$E = E_0 - \frac{RT}{nF} \ln \frac{a_M^{(z-n)+}}{a_M^{z+}} \quad \dots (2)$$

E: Electric potential E_0 : Constant R: Gas constant T: Absolute temperature

n: Electron count F: Faraday constant a: Activity

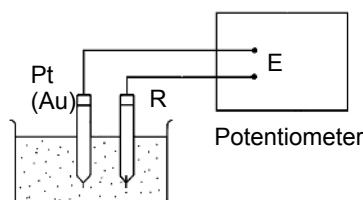
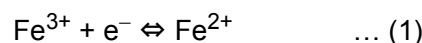

Fig. 8 Measuring mV

For example, for a solution in which trivalent iron ions coexist with bivalent iron ions, equations 1 and 2 would be as follows.



$$E = E_0 - \frac{RT}{F} \ln \frac{a_{Fe^{2+}}}{a_{Fe^{3+}}} \quad \dots (2)$$

When only one type of state of equilibrium uniquely by equation (Fe^{3+}) and the reductant (Fe^{2+}) (using the equation $a_{\text{Fe}^{2+}}/a_{\text{Fe}^{3+}}$). Actually, however many kinds of states of equilibrium exist simultaneously between various kinds of ions, in most solutions. This means that under actual circumstances, ORP cannot be expressed using the simple equation shown above and that the physical and chemical significance with respect to the solution is not very clear.

In this respect, the value of ORP must be understood to be only one indicator of the property of a solution. The measurement of ORP is widely used, however, as an important index in the analysis of solutions (potentiometric titration) and in the waste water treatment.

6.11.2 Standard electrode (reference electrode) types and ORP

The ORP is obtained comparing with corresponding reference electrode employed.

If different kinds of reference electrodes are used for measurement, the ORP value of the same solution may appear to be different. HORIBA Advanced Techno's reference electrode uses Ag/AgCl with 3.33 mol/L KCl as inner solution. According to general technical literature, normal hydrogen electrodes (N.H.E.) are often used as the standard electrode.

The relationship between N.H.E. and the ORP that is measured using an Ag/AgCl with 3.33 mol/L KCl electrode is expressed by the following equation.

$$E_{\text{N.H.E.}} = E + 206 - 0.7(t - 25) \text{ mV} \quad t = 0 - 60^\circ\text{C}$$

$E_{\text{N.H.E.}}$: Measured ORP value using N.H.E. as the reference electrode

E: Measured ORP value using Ag/AgCl with 3.33 mol/L KCl as the reference electrode
Potential sign

Standard ORP is expressed in the following way, in literature related to electrochemistry and analytical chemistry.

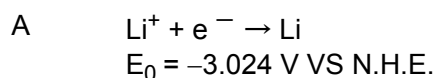

However, in some literature, the "+" and "-" signs are reversed.

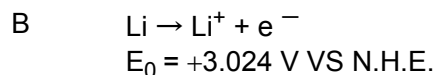

In expressions like B, above, the reaction is just reversed and there is no essential difference. But this kind of expression does invite confusion. The majority of the world, today, is consistent in its use of the signs as they are used in A, above.

For this reason, HORIBA Advanced Techno, too, uses signs concerning ORP that are consistent with A, above.

HORIBA Advanced Techno
<http://www.horiba-adt.jp>

Headquarters
31, Miyanonishi-cho, Kisshoin Minami-ku, Kyoto 601-8306, Japan
TEL:+81-75-321-7184 FAX:+81-75-321-7291
